



10



钢球

Berus Siput S/Still Papan Jaws	S. Price
S/15 — 9555 48351 1600	8.80/Doz
36 Papan X 2 Doz	
S/15 — 9555 48350 0819	8.80/Doz
72 Papan x 1 Doz	

3

25



钢球

Berus Siput S/Still Papan Jaws	S. Price
M/30 — 9555 48351 1587	16.80/Doz
48 Papan x 1 Doz	
L/50 — 9555 48351 1570	20.00/Doz
36 Papan x 1 Doz	
XL/100 — 9555 48351 1594	31.60/Doz
18 Papan x 1 Doz	

4

20

26



钢球 A-1 (Qty: 30 Papan x 1 Doz)

Berus Siput Stainless Steel A-1 Papan 50g	S. Price
9555 48350 1670	27.60/Doz

6



10

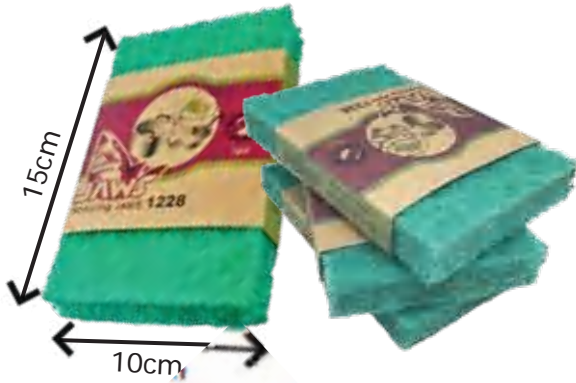

大片台湾1"青色青布 (Qty: 24 Pcs x 12 Bks)

Berus Hijau JAWS Besar 1228HJ HIJAU 1"	S. Price
9555 48351 1228	2.50/Pcs

8-HJ

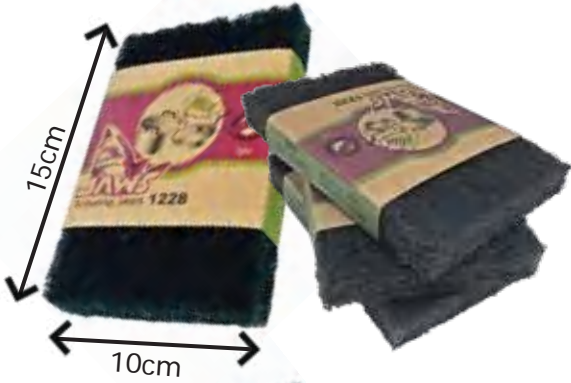

大片台湾1"黑色青布 (Qty: 24 Pcs x 12 Bks)

Berus Hijau JAWS Besar 1228HT HITAM 1"	S. Price
9555 48351 1754	2.50/Pcs

8-HT

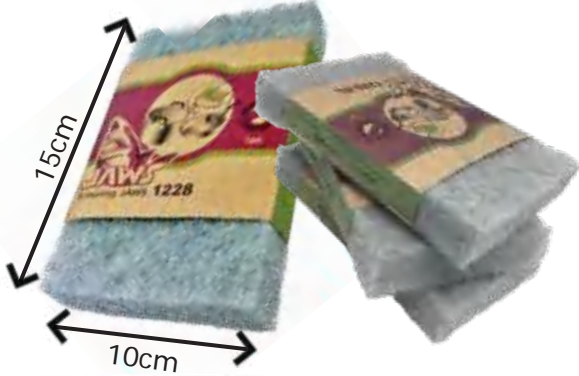

大片台湾1"银色青布 (Qty: 24 Pcs x 12 Bks)

Berus Hijau JAWS Besar 1228SL SILVER 1"	S. Price
9555 48351 1761	2.50/Pcs

8-SL

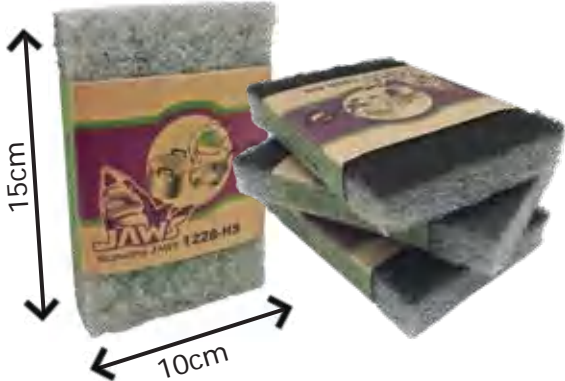

大片台湾1"两色青布 (Qty: 24 Pcs x 12 Bks)

Berus Hijau JAWS Besar 1228HS HITAM SILVER 1"	S. Price
9555 48351 1778	2.50/Pcs

8-HS



10



泰国加大青布 (Qty: 12 Doz x 1 Ctn)

Berus Hijau JAWS Thailand	S. Price
6" X 9"	19.20/Doz
9555 48351 1259	

12



小片1"台湾银色青布 (Qty: 50 Pcs x 20 Bks)

Berus Hijau JAWS Kecil 1327SL SILVER 1"	S. Price
9555 48351 1792	1.20/Pcs

14-SL



小片1"台湾青色青布 (Qty: 50 Pcs x 20 Bks)

Berus Hijau JAWS Kecil 1327HJ HIJAU 1"	S. Price
9555 48351 1327	1.20/Pcs

14-HJ

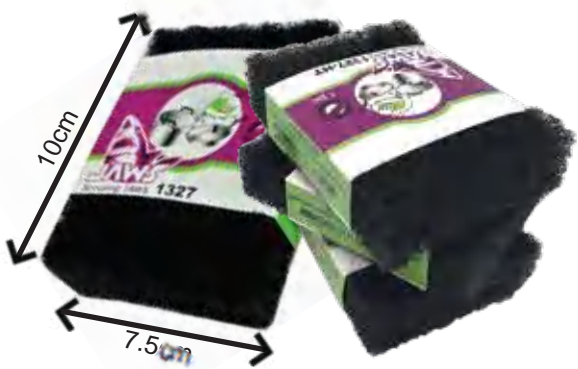

小片1"台湾黑色青布 (Qty: 50 Pcs x 20 Bks)

Berus Hijau JAWS Kecil 1327HT HITAM 1"	S. Price
9555 48351 1785	1.20/Pcs

14-HT



小片1"台湾两色青布 (Qty: 50 Pcs x 20 Bks)

Berus Hijau JAWS Kecil 1327HS HITAM/SILVER 1"	S. Price
9555 48351 1808	1.20/Pcs

14-HS



10



铅球 (Qty: 12 Pcs x 60 Bks)

Berus Sanggul	S. Price
15g - 9555 48350 0444	6.40/Doz

1



铅球 (Qty: 12 Pcs x 12 Bks)

Berus Sanggul 100gm	S. Price
9555 48350 1724	3.60/Pcs

18



50克铅球 (Qty: 12 Pcs x 30 Bks)

Berus Sanggul Tanpa Papan 50gm	S. Price
9555 48350 1717	1.75/Pcs

19



金葱球 (Qty: 20 Doz x 1Ctn)

Berus Sanggul Plastic	S. Price
~	28.80/Doz

17

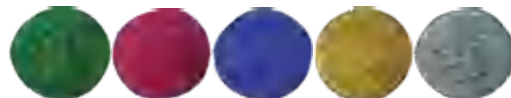



10

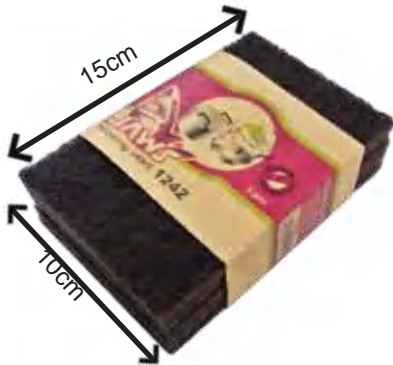

5头台湾棕色青布 (Qty: 24 Set x 10 Bks)

Berus Hijau JAWS TAIWAN 5 Susun 1242	S. Price
Warna BROWN	4.30/Set
9555483511242	

28-BR



5头台湾青布 (Qty: 24 Set x 10 Bks)

Berus Hijau JAWS TAIWAN 5 Susun 1242	S. Price
Warna HIJAU	4.30/Set
9555483511242	

28-HJ

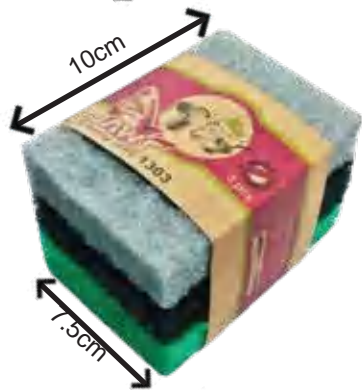

3头台湾青布 (Qty: 25 Set x 12 Bks)

Berus Hijau JAWS TAIWAN 1"	S. Price
3 Susun MIX 1303	3.90/Set
9555483511303	

29



3头台湾青布 (Qty: 24 Set x 12 Bks)

Berus Hijau JAWS TAIWAN	S. Price
3 Susun 1310	5.00/Set
9555483511310	

30



10



5"x 8"小霸王青布 (Qty: 12 Pcs X 20 Papan)

5"x 8" Berus Hijau Scouring Buick	S. Price
9555 48350 1533	4.00/Pcs

10



三片庄小霸王青布 (Qty: 12 Pek X 12 Papan)

3 Pcs Berus Hijau Scouring Brick	S. Price
9555 48350 1564	5.00/Pc

21





10



水晶柄奶开 (Qty: 1 Doz x 50 Ktk)

Buka Susu Thailand	S. Price
A80	65.00/Doz

2



10



三公斤/英磅糕秤 (Qty: 24 Pcs x 1Ctn)

Dacing 3kg / lbs KIBI	S. Price
9555 48350 1540	RM 17.60/Pcs

1



数字电子秤 (Qty: 24 Pcs x 1Ctn)

Penimbang Digital 3 Kg	S. Price
9555 48351 0511	RM 35.00/Pcs

4

镀盘秤 **TIDAK UNTUK PERDAGANGAN**

Dacing	S. Price
10 Kg-(8 Pcs X 1 Ctn)	RM 78.00/Pcs
20 Kg-(8 Pcs X 1 Ctn)	RM 98.00/Pcs
50 Kg-(4 Pcs X 1 Ctn)	RM 165.00/Pcs
100 Kg-(2 Pcs X 1 Ctn)	RM 330.00/Pcs

6

5

3

2





10

炉脚片



Dapur Kaki Keping	S. Price
5 1/2" (80 Pcs x 1 Ctn)	RM 6.20/Pcs
6" (80 Pcs x 1 Ctn)	RM 6.80/Pcs
6 1/2" (60 Pcs x 1 Ctn)	RM 7.40/Pcs
7" (60 Pcs x 1 Ctn)	RM 8.00/Pcs
8" (60 Pcs x 1 Ctn)	RM 9.40/Pcs

16

17

18

19

21



生铁炉脚

Dapur Kaki	S. Price
5 1/2" (72 Pcs x 1 Ctn)	RM 8.30/Pcs
6" (72 Pcs x 1 Ctn)	RM 9.50/Pcs

23

24



黑煤气炉脚 (60 Pcs x 1 Ctn)

Dapur Kaki Gas Hitam	S. Price
9555 48350 1380	RM 5.70/Pcs

15



加厚煤气炉脚 (60 Pcs x 1 Ctn)

Dapur Kaki Gas Tebal 1588	S. Price
9555 48350 1588	RM 9.00/Pcs

45



10



勺子 (Qty: 100 Doz x 1 Ctn)

Sudu No. 303	S. Price
9555 48350 1403	RM 4.60/Doz

1



320g/Doz

5线勺子 (Qty: 100 Doz x 2 Ctn)

Sudu No. 925	S. Price
9555 48351 2812	RM 7.60/Doz

3



294g/Doz

光身勺子 (Qty: 100 Doz x 2 Ctn)

Sudu S/Steel 915	S. Price
9555 48351 2836	RM 7.60/Doz

9

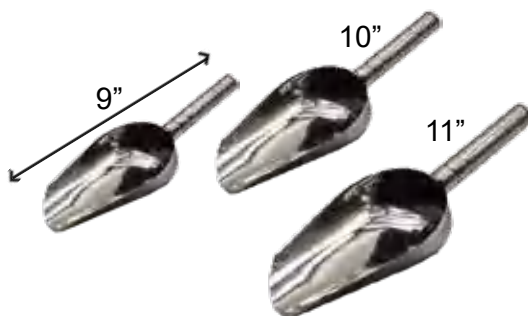

钢冰铲 (Qty: 6 Pcs x 6 Bks)

Skop Air Batu S/Steel	S. Price
9" - (6942 00086 0984)	RM 7.20/Pcs
10" - (6942 00086 0991)	RM 8.60/Pcs
11" - (6942 00086 1004)	RM 10.80/Pcs

10

11

12

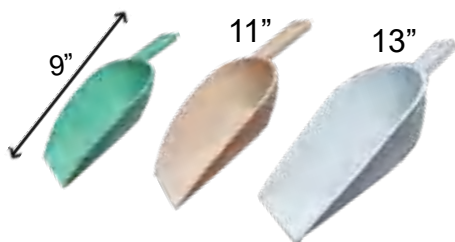

泰国塑胶冰铲 (Qty: 72 Pcs x 1 Ctn)

Skop Air Batu Plastik Thailand	S. Price
RW0014 9" - (8850421001405)	RM 3.80/Pcs
RW0015 11" - (8850421001504)	RM 5.70/Pcs
RW0016 13" - (8850421001603)	RM 9.70/Pcs

10-P

11-P

12-P



10



叉 (Qty: 100 Doz x 1 Ctn)

Garpu No. 303	S. Price
9555 48351 2805	4.60/Doz

1



5线叉 (Qty: 100 Doz x 1 Ctn)

Garpu No. 925	S. Price
9555 48351 2829	7.60/Doz

3



光身叉 (Qty: 100 Doz x 1 Ctn)

Garpu S/Steel 915	S. Price
9555 48351 2843	7.60/Doz

4



10



单头白钢炉 (Qty: 10 Set x 1 Ctn)

Dapur Gas S/Steel Single PENTEC MD-211	S. Price
9555 02910 1111	RM 72.00/Set

27

双头炉 (Qty: 10 Set x 1 Ctn)

Dapur Gas Epoxy Double PENTEC MD-811	S. Price
9555 02910 1814	RM 110.00/Set

39

双煤气炉 (Qty: 10 Set x 1 Ctn)

Dapur Gas S/Steel Double SUPA 7102 SIRIM	S. Price
9555 48350 1977	RM 110.00/Set

49



10



手提餐炉 (Qty: 8 Set x 1 Ctn)

Dapur Gas Steamboat ZCM-001	S. Price	46
	RM 67.00/Set	



方形野餐炉 (Qty: 48 Pcs X 1 Ctn)

Dapur Gas Berkelah Segiempat No.202	S. Price	47
9555 48351 0597	RM 32.00/Pcs	



莲花形防风野餐炉 (Qty: 50 Pcs X 1 Ctn)

Dapur Gas Berkelah Bulat No.203	S. Price	48
9555 48351 0603	RM 48.00/Pcs	



10

黑鼎



Kawah	S. Price
81cm — 14kg / Pcs	RM 286.00/Pcs
10 Pcs x 1 Ctn	
95cm — 20kg / Pcs	RM 396.00/Pcs
10 Pcs x 1 Ctn	
119cm — 45kg / Pcs	RM 826.00/Pcs
5 Pcs x 1 Ctn	

77

35

36

蚝煎鼎



Kuali Leper	S. Price
27" — 12kg	RM 240.00/Pcs
10 Pcs X 1 Ctn	

51

双耳蚝煎鼎



Kuali Leper Telinga	S. Price
27" — 12kg	RM 250.00/Pcs
10 Pcs X 1 Ctn	

51-T

黑鼎



Kuali Hitam	S. Price
13" — 12 Pcs x 6 Ctn	RM 30.00/Pcs
14" — 12 Pcs x 6 Ctn	RM 33.00/Pcs
15" — 15 Pcs x 6 Ctn	RM 42.00/Pcs
16" — 10 Pcs x 6 Ctn	RM 52.00/Pcs
17" — 10 Pcs x 6 Ctn	RM 62.00/Pcs
18" — 10 Pcs x 6 Ctn	RM 73.00/Pcs
19" — 10 Pcs x 6 Ctn	RM 83.00/Pcs
20" — 5 Pcs x 6 Ctn	RM 92.00/Pcs
21" — 7 Pcs x 6 Ctn	RM 104.00/Pcs
22" — 5 Pcs x 6 Ctn	RM 128.00/Pcs
24" — 5 Pcs x 6 Ctn	RM 160.00/Pcs
27" — 5 Pcs x 6 Ctn	RM 200.00/Pcs

22

23

24

25

26

27

28

29

30

31

32

33



10

光面铝鼎

Kuali Aluminium Kilat KIBI	Price	
10" (9555483510887) - 25Pcs x 1Ctn	RM 23.60/Pcs	68
11" (9555483510894) - 25Pcs x 1Ctn	RM 26.80/Pcs	69
12" (9555483510900) - 25Pcs x 1Ctn	RM 29.40/Pcs	70
13" (9555483510917) - 25Pcs x 1Ctn	RM 33.40/Pcs	71
14" (9555483510924) - 25Pcs x 1Ctn	RM 38.00/Pcs	72
15" (9555483510931) - 25Pcs x 1Ctn	RM 42.60/Pcs	73
16" (9555483510948) - 20Pcs x 1Ctn	RM 49.20/Pcs	74
17" (9555483510955) - 20Pcs x 1Ctn	RM 56.40/Pcs	75
18" (9555483510962) - 15Pcs x 1Ctn	RM 64.80/Pcs	76
19" (9555483510979) - 15Pcs x 1Ctn	RM 74.00/Pcs	78
20" (9555483510986) - 10Pcs x 1Ctn	RM 85.40/Pcs	79
21" (9555483510870) - 10Pcs x 1Ctn	RM 94.00/Pcs	81
22" (9555483510993) - 10Pcs x 1Ctn	RM 102.40/Pcs	80
24" (9555483510559) - 10Pcs x 1Ctn	RM 221.80/Pcs	82





10

铝鼎

Kuali Aluminium	S. Price
10" (30 Pcs X 1 Ctn)	21.20/Pcs
11" (30 Pcs X 1 Ctn)	22.60/Pcs
12" (30 Pcs X 1 Ctn)	25.00/Pcs
13" (30 Pcs X 1 Ctn)	27.80/Pcs
14" (30 Pcs X 1 Ctn)	32.20/Pcs
15" (30 Pcs X 1 Ctn)	36.40/Pcs
16" (25 Pcs X 1 Ctn)	40.80/Pcs
17" (25 Pcs X 1 Ctn)	45.00/Pcs
18" (15 Pcs X 1 Ctn)	51.40/Pcs
19" (15 Pcs X 1 Ctn)	59.80/Pcs
20" (10 Pcs X 1 Ctn)	68.40/Pcs
21" (10 Pcs X 1 Ctn)	76.50/Pcs
22" (10 Pcs X 1 Ctn)	85.40/Pcs
24" (10 Pcs X 1 Ctn)	171.00/Pcs
27" (5 Pcs X 1 Ctn)	213.40/Pcs
30" (5 Pcs X 1 Ctn)	364.00/Pcs

3

4

5

6

7

8

9

10

11

12

13

14

15

16

17

18





10



粗面石臼 (Qty: 4 Set x 2 Ctn)

Batu Lesung Permukaan Kasar	S. Price
14.5cm (9555 48351 1860)	RM 53.00/Set
16.0cm (9555 48351 1877)	RM 61.00/Set
17.5cm (9555 48351 1884)	RM 69.00/Set

2

3

4



滑身石臼 (Qty: 4 Set x 2 Ctn)

Lesung Kilat	S. Price
13.0cm (9555 48351 0641)	RM 35.40/Set
14.5cm (9555 48351 0658)	RM 39.00/Set
16.0cm (9555 48351 0665)	RM 44.00/Set
17.5cm (9555 48351 0672)	RM 48.00/Set

15

16

17

18

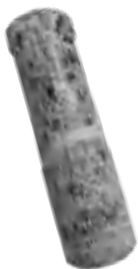

石臼柄

Anak Lesung Kilat	S. Price
16cm (Qty: 40 Pcs X 1 Ctn)	RM 9.50/Pcs
19cm (Qty: 30 Pcs X 1 Ctn)	RM 13.60/Pcs

20

21



10

烧鱼夹

Panggang Ikan	S. Price
XL - No.1 (加大) 1 Ctn x 9 Doz	RM 14.00/Pcs 1
L - No.2 (大) 1 Ctn x 10 Doz	RM 12.00/Pcs 2

烧烤钢网 (Qty: 100 Pcs x 1 Ctn)

Tray Pemanggang S/Steel	S. Price
Kecil - 44cm X 26cm	RM 9.60/Pcs 4
9555 48351 6902	
Besar - 61cm X 26cm	RM 13.00/Pcs 5
9555 48351 6919	

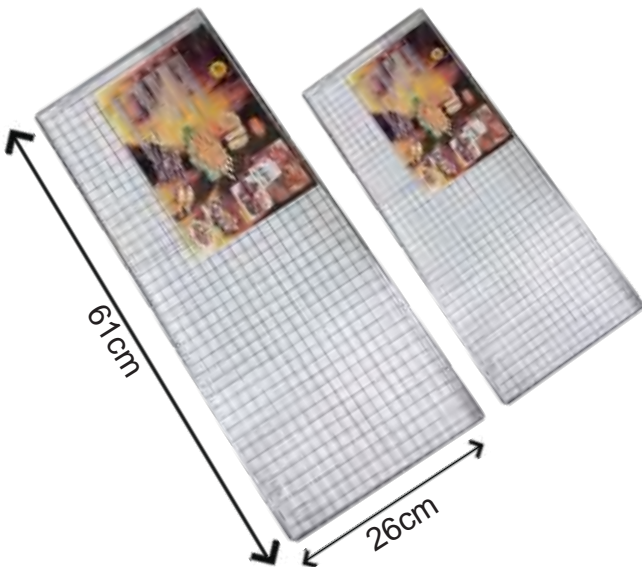



SIN TAI SOON SDN. BHD. (116948-X)

新大順貿易有限公司

15

10



大生牌有盖口杯

Kole S/Steel	S. Price
10cm — 10 pcs x 15 KTK	9.20/pcs
12cm — 8 pcs X 15Ktk	13.40/pcs

1
2



SIN TAI SOON SDN. BHD. (116948-X)

新大順貿易有限公司

26/4/24

18

10



椰肉巴律 (Qty: 50 Doz x 1 Ctn)

Parut Isi Kelapa	S. Price
9555 48351 0214	RM 4.00/Pcs

6



10



奇鱼标胶柄果刀 (Qty: 50 Doz)

Pisau Kibi 511	S. Price
9555 48351 1105	15.60/Doz

13

奇鱼标胶柄钢刀



Pisau Kibi	S. Price
4" — 9555 48350 1595	21.00/Doz
30 Doz x 1 Ctn	
5" — 9555 48350 1601	25.60/Doz
30 Doz x 1 Ctn	
6" — 9555 48350 1618	28.80/Doz
30 Doz x 1 Ctn	
7" — 9555 48350 1625	33.00/Doz
30 Doz x 1 Ctn	
8" — 9555 48350 1632	36.00/Doz
30 Doz x 1 Ctn	

14

15

16

17

18



奇鱼标木柄果刀 (Qty: 50 Doz x 1 Ctn)

Pisau Kibi 501	S. Price
9555 48351 1099	14.40/Doz

20



10

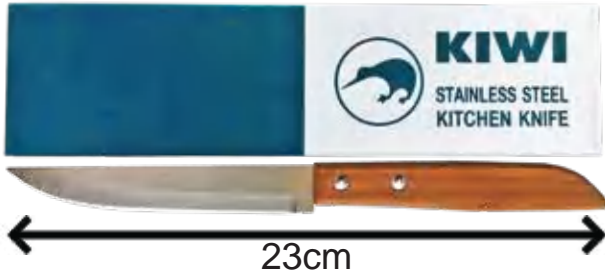

正泰国KIWI刀 (Qty: 50 Doz x 1 Ctn)

Pisau KIWI Thailand 9" No.501	S. Price
8851130050326	RM 93.50/Doz

61

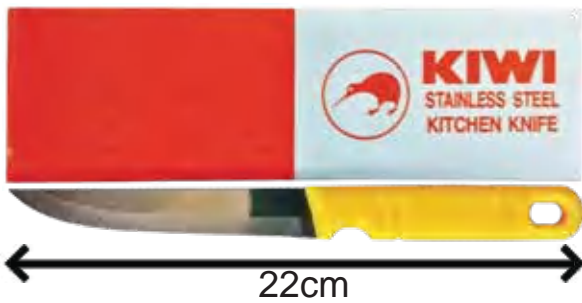

正泰国KIWI刀 (Qty: 50 Doz x 1 Ctn)

Pisau KIWI Thailand 8.5" No.511	S. Price
8851130050388	RM 70.00/Doz

62



正泰国KIWI刀 (Qty: 2 Doz x 50 Box)

Pisau KIWI Thailand 6.5" No.001	S. Price
8851 13005 0012	RM 60.00/Doz

78



10



正泰国KIWI刀 (Qty: 10 Doz x 1 Ctn)

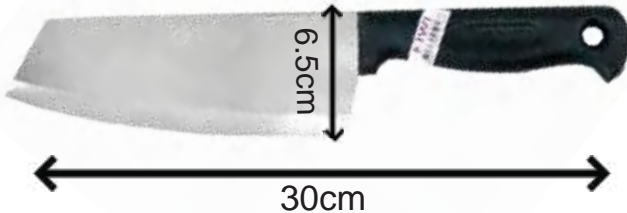

Pisau KIWI Thailand 12" No. 211-P	S. Price
8851 13005 0166	RM 260.00/Doz

64



正泰国KIWI刀 (Qty: 20 Doz x 1 Ctn)

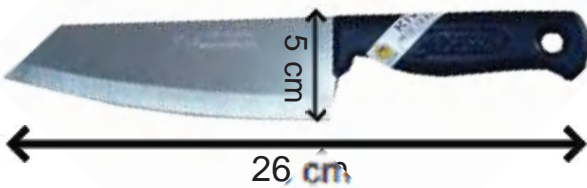

Pisau KIWI Thailand 10" No.171-P	S. Price
8851 13005 0050	RM 160.00/Doz

79



正泰国KIWI刀 (Qty: 20 Doz x 1 Ctn)

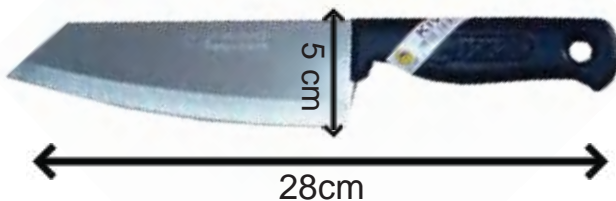

Pisau KIWI Thailand 11" No.173-P	S. Price
8851 13005 0067	RM 154.00/Doz

81



正泰国KIWI刀 (Qty: 20 Doz x 1 Ctn)

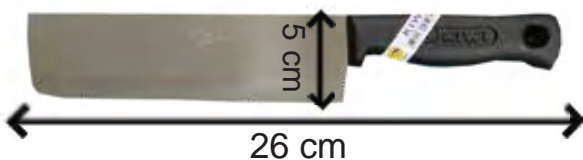

Pisau KIWI Thailand 6" No.172-P	S. Price
8851 13005 0616	RM 158.00/Doz

80



10

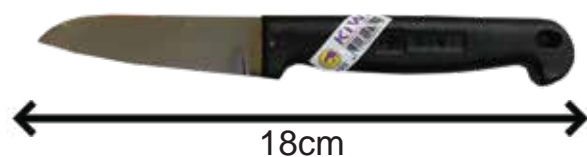

18cm

正泰国KIWI刀 (Qty: 50 Doz x 1 Ctn)

Pisau KIWI Thailand 3" No.193	S. Price
8851 13005 0104	RM 60.00/Doz

82



21cm

正泰国KIWI刀 (Qty: 50 Doz x 1 Ctn)

Pisau KIWI Thailand 4" No.194	S. Price
8851 13005 0111	RM 70.00/Doz

83



29cm

正泰国KIWI刀 (Qty: 20 Doz x 1 Ctn)

Pisau KIWI Thailand 7" No.197	S. Price
8851 13005 0135	RM 163.50/Doz

84



10



瓜刨

Kupas Buah KIWI Thailand	S. Price	
No.118 - Kecil 1 Ctn x 100 Doz	61.20/Doz	65
No.411 - Besar 1 Ctn x 50 Doz	80.00/Doz	66

正泰国KIWI刀



Pisau KIWI Thailand	S. Price	
No. 474 - 4" (40 Doz x 1 Ctn)	82.50/Doz	47
No. 475 - 5" (40 Doz x 1 Ctn)	93.00/Doz	48
No. 476 - 6" (20 Doz x 1 Ctn)	119.00/Doz	49
No. 477 - 7" (20 Doz x 1 Ctn)	135.60/Doz	50
No. 478 - 8"	153.40/Doz	52

正泰国KIWI刀



Pisau KIWI Thailand	S. Price	
No. 830 (6 Doz x 1 Ctn)	23.20/Pcs	53
No. 840 (6 Doz x 1 Ctn)	36.00/Pcs	54
No. 850 (6 Doz x 1 Ctn)	44.70/Pcs	55



SIN TAI SOON SDN. BHD. (116948-X)

新大順貿易有限公司

20

10



十八子木柄斩切刀 (Qty: 12 Pcs x 1 Ctn)

Pisau Dapur Shibazi D01	S. Price
6920 26450 0822	63.00/Pcs

70



十八子木柄斩切刀 (Qty: 12 Pcs x 1 Ctn)

Pisau Dapur Shibazi D02	S. Price
6920 26450 0832	56.00/Pcs

71



10

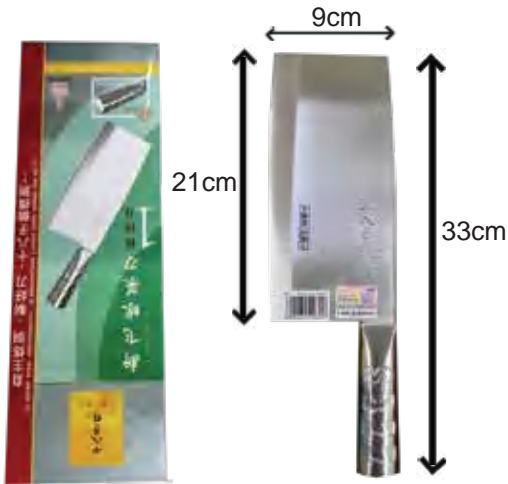

十八子钢柄斩切刀(Qty: 12 Pcs x 1 Ctn)

Pisau Dapur Shibazi P01	S. Price
6920 26451 2399	69.60/Pcs

72

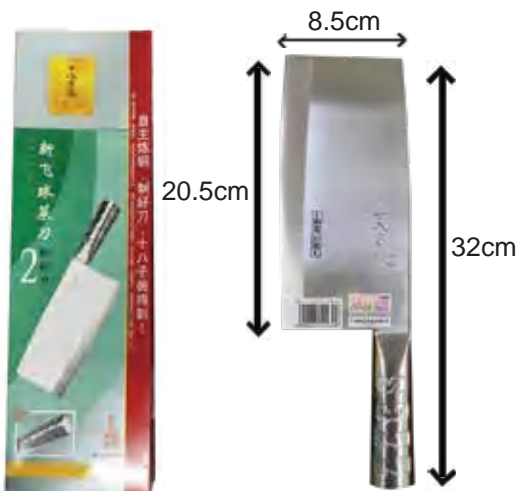

十八子钢柄斩切刀(Qty: 12 Pcs x 1 Ctn)

Pisau Dapur Shibazi P02	S. Price
6920 26451 2368	68.00/Pcs

73

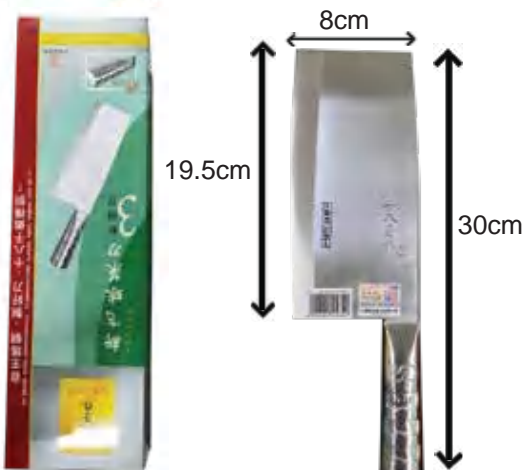

十八子钢柄斩切刀 (Qty: 12 Pcs x 1 Ctn)

Pisau Dapur Shibazi P03	S. Price
6920 26451 2375	66.00/Pcs

74

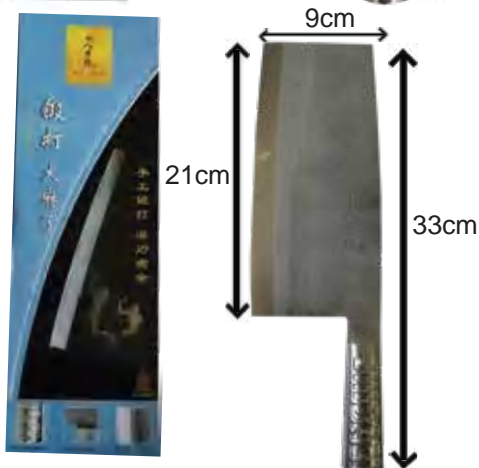

十八子钢柄斩切刀 (Qty: 12 Pcs x 1 Ctn)

Pisau Dapur Shibazi SD712	S. Price
6935 73270 5951	69.60/Pcs

77



10



榴蓮刀 (Qty: 10 Pcs x 5 Ctn)

Pisau Durian Tangkai Besi	S. Price
9555 48350 1984	RM 19.00/Pcs

46

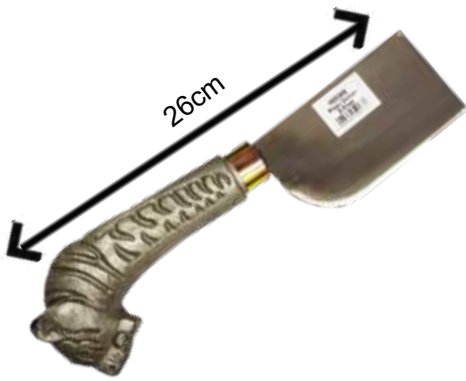

钢榴蓮刀 (Qty: 10 Pcs x 3 Ctn)

Pisau Durian S/Steel Cap Kelapa Sawit 1731	S. Price
9555 48350 1731	RM 32.00/Pcs

69



钢榴蓮刀 (Qty: 10 Pcs x 3 Ctn)

Pisau Durian S/Steel Cap Kelapa Sawit 0337	S. Price
9555 48351 0337	RM 39.60/Pcs

85

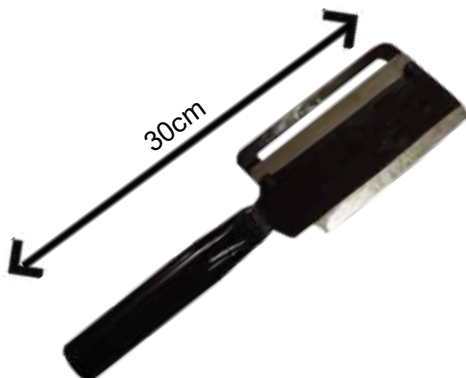

甘蔗刀 (Qty: 6 Pcs x 5 Ctn)

Pisau Tebu	S. Price
9555 48351 0535	RM 17.40/Pcs

75



10

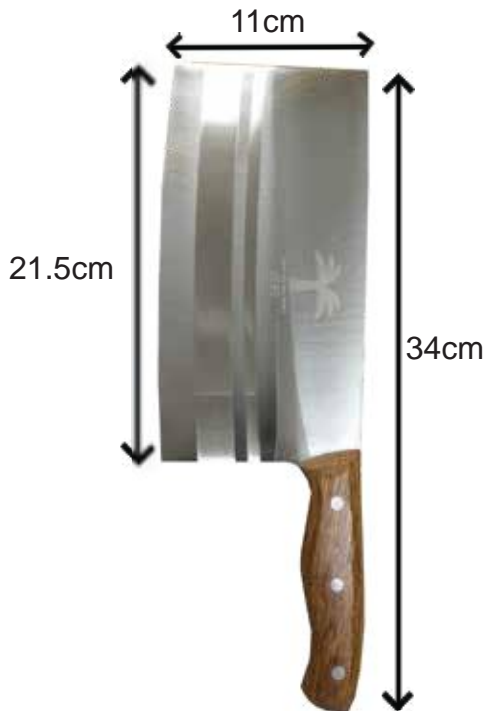

棕油树菜刀 (Qty: 40 Pcs x 1 Ctn)

Pisau Dapur Cap Kelapa Sawit 0689	S. Price
9555 48351 0689	34.80/Pcs

1

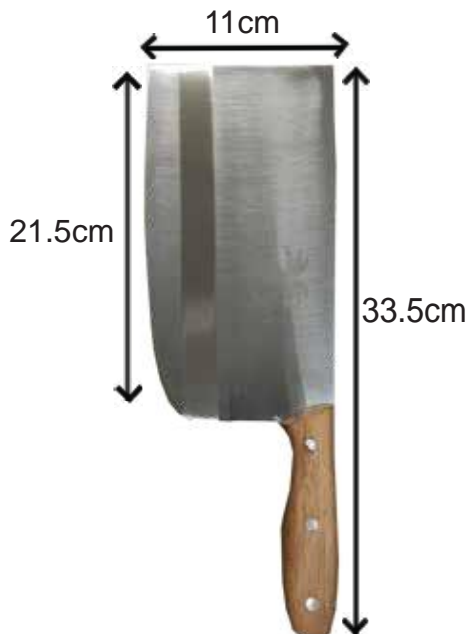

棕油树菜刀 (Qty: 40 Pcs x 1 Ctn)

Pisau Dapur Cap Kelapa Sawit 0696	S. Price
9555 48351 0696	34.80/Pcs

2



双狮菜刀 (Qty: 50 Pcs x 1 Ctn)

Pisau Double Lion	S. Price
No.1 一号	26.50/Pcs
No.2 二号	25.50/Pcs

26

27



10



G-02可伦比亚童军刀 (12 Pcs x 2 Ktk)

Pisau Pengakap Cap COLUMBIA	S. Price
G-02 (9555 48351 1952)	41.00/Pcs

33



G-09可伦比亚童军刀 (12 Pcs x 2 Ktk)

Pisau Pengakap Cap COLUMBIA	S. Price
G-09 (9555 48351 1969)	41.00/Pcs

34



G-17可伦比亚童军刀 (12 Pcs x 2 Ktk)

Pisau Pengakap Cap COLUMBIA	S. Price
G-17 (9555 48351 1976)	41.00/Pcs

35



G-08可伦比亚童军刀 (12 Pcs x 2 Ktk)

Pisau Pengakap Cap COLUMBIA	S. Price
G-08 (9555 48351 0528)	41.00/Pcs

76



10

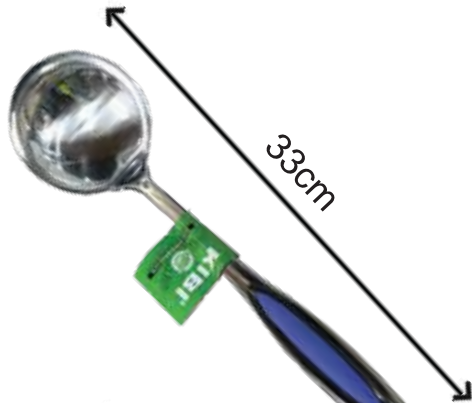

加厚白钢壳 (Qty: 10 Doz X 1 Ctn)

Senduk Kuah S/Steel Tebal No.1631	S. Price
9555 48351 1631	90.00/Doz

11

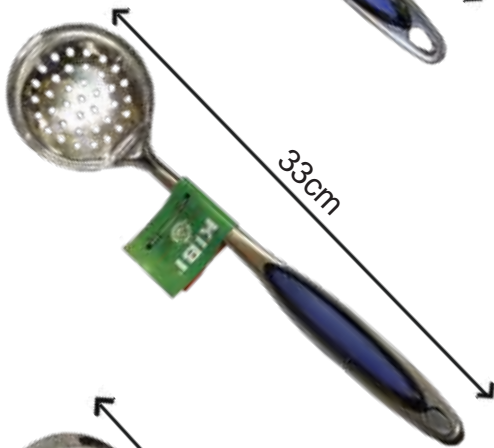

加厚有洞白钢壳 (Qty: 10 Doz X 1 Ctn)

Senduk Kuah S/Steel Tebal Berlubang No.1648	S. Price
9555 48351 1648	90.00/Doz

28

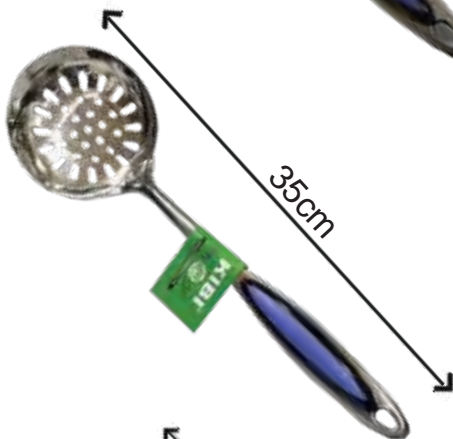

加厚有洞白钢壳 (Qty: 10 Doz X 1 Ctn)

Senduk Kuah S/Steel Tebal Berlubang No.0474	S. Price
9555 48351 0474	90.00/Doz

29

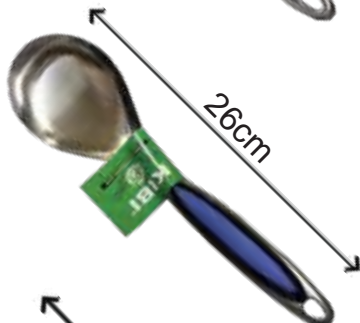

加厚白钢饭匙 (Qty: 10 Doz X 1 Ctn)

Senduk Nasi S/Steel Tebal No.0481	S. Price
9555 48351 0481	62.40/Doz

30

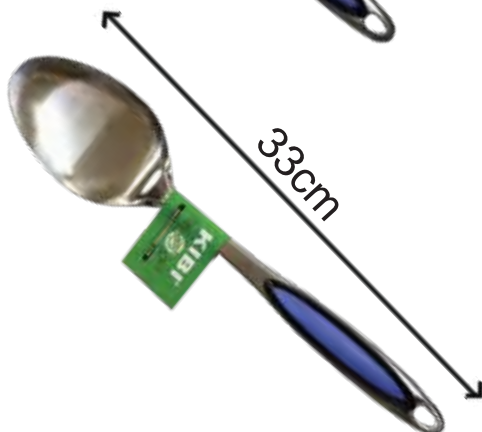

加厚白钢饭匙 (Qty: 10 Doz X 1 Ctn)

Senduk Nasi S/Steel Tebal No.0498	S. Price
9555 48351 0498	76.80/Doz

31



10



泰国塑料柄钢饭匙 (Qty: 12 Doz x 1 Ctn)

Senduk Nasi Thailand Tangkai Plastik	S. Price
~	RM 32.00/Doz

7



有洞汤壳 (Qty: 12 Doz x 1 Ctn)

Senduk Kuah Berlubang Tangkai Hitam	S. Price
~	RM 37.00/Doz

18

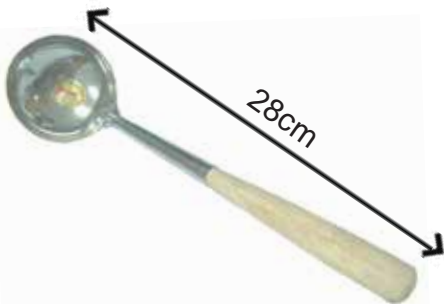

泰国木柄壳 (Qty: 12 Doz x 1 Ctn)

Senduk Thai Tangkai Kayu	S. Price
~	RM 37.00/Doz

15



泰国黑柄壳 (Qty: 12 Doz x 1 Ctn)

Senduk Thai Tangkai Hitam	S. Price
~	RM 37.00/Doz

16



10



加厚白钢煎匙 (Qty: 12 Doz x 1 Ctn)

Sudip S/Steel Tebal 1624	S. Price
~	76.80/Doz

1



有洞加厚白钢煎匙 (Qty: 12 Doz x 1 Ctn)

Sudip S/Steel Tebal Berlubang 1655	S. Price
9555 48351 1655	76.80/Doz

11



泰国黑柄煎匙 (Qty: 12 Doz x 1 Ctn)

Sudi4p Thai Tangkai Hitam	S. Price
3'	37.00/Doz
4'	59.00/Doz

3

4



泰国木柄煎匙 (Qty: 12 Doz x 1 Ctn)

Sudip Thailand Tangkai Kayu	S. Price
3"	37.00/Doz
4"	59.00/Doz

5

9



三寸泰国有洞箭匙 (Qty: 12 Doz x 1 Ctn)

3" Sudip Lubang Thai	S. Price
~	37.00/Doz

7

SIN TAI SOON SDN. BHD. (116948-X)

新大順貿易有限公司
22
10

木饭匙 (Qty: 60 Pcs x 2 Ctn)

Senduk Nasi Kayu 0429	S. Price
9555 48351 0429	RM 6.00/Pcs

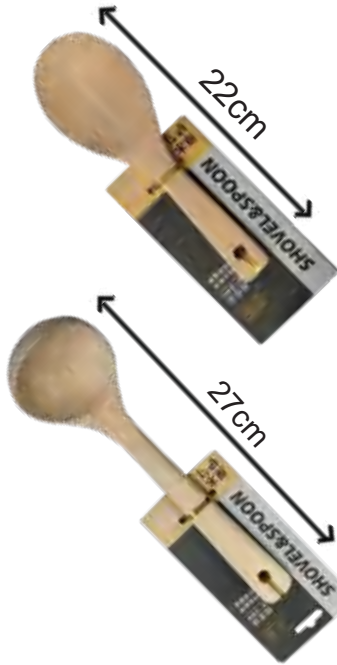
32

木汤壳 (Qty: 60 Pcs x 1 Ctn)

Senduk Kuah Kayu 0436	S. Price
9555 48351 0436	RM 13.00/Pcs

33

SIN TAI SOON SDN. BHD. (116948-X)

新大順貿易有限公司
25
10

木煎匙 (Qty: 60 Pcs x 2 Ctn)

Sudip Kayu 0443	S. Price
9555 48351 0443	RM 5.00/Pcs

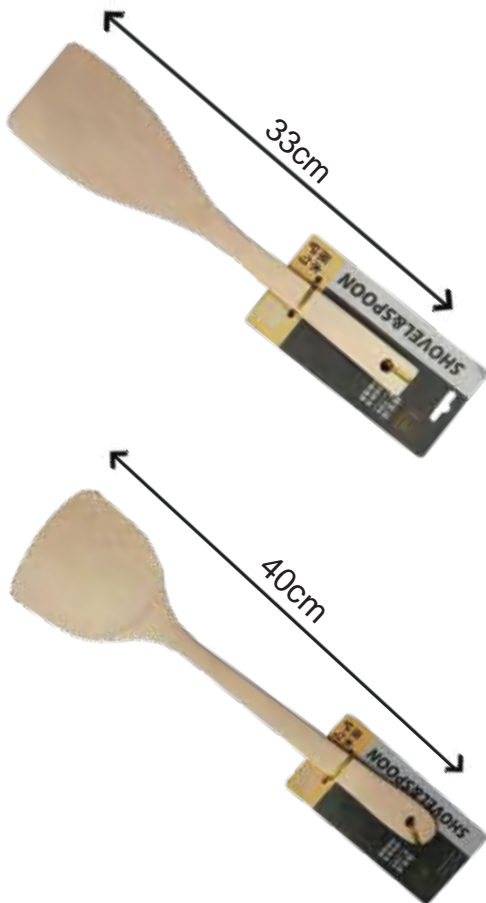
12

木煎匙 (Qty: 60 Pcs x 2 Ctn)

Sudip Kayu 0450	S. Price
9555 48351 0450	RM 7.20/Pcs

13



10

六寸冰夹



Sepit Ais	S. Price
6" (Qty: 10 Pcs x 12 Ikat)	1.50/Pcs

1

食物夹



Sepit Kuih S/Steel	S. Price
9" - 9555 48351 1679	1.95/Pcs
QTY:10 PCS X 5Bks X 12KTK	
12" - 9555 48351 1686	2.40/Pcs
QTY:10PCS X 5Bks X 12KTK	
14" - 9555 48351 1693	3.00/Pcs
QTY:10PCS X 5Bks X 12KTK	
16" - 9555 48351 1709	3.50/Pcs
QTY:10PCS X 5Bks X 10KTK	

2

3

4

5



面包夹 (Qty: 120 Pcs x 1 Ctn)

Sepit Roti Plastic	S. Price
~	5.40/Pcs

13

食物夹 (Qty: 120 Pcs x 1 Ctn)



Sepit Kuih Stainless Steel Tebal	S. Price
9" 0501	3.90/Pcs

19



10

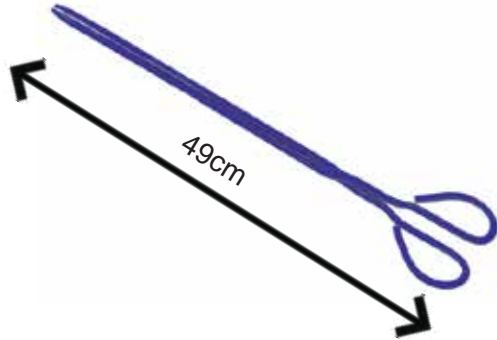

一号高温不锈火炭夹 (Qty: 10 Pcs x 10 Ikat)

Sepit Arang Cina No.1	S. Price
~	5.80/Pcs

11



电白火炭夹(Qty:10 Pcs x 12 Ikat)

Sepit Arang KROM 53cm	S. Price
Panjang	12.00/Pcs

22



1800系列取物夹铁 (Qty: 120 Pcs x 1 Ctn)

Sepit Barang Tangkai Besi	S. Price
~	9.20/Pcs

17



1000系列取物夹塑料1米 (Qty: 60 Pcs x 1 Ctn)

Sepit Barang Tangkai Plastik	S. Price
~	4.00/Pcs

18



10



3M 排庄青布 (Qty: 12 Pcs x 20 Papan)

3M Scotch-Brite Berus Hijau Siap Papan	S. Price
4800 31400 0026	RM 2.50/Pcs

33



3M5头青布 (Qty: 24 Set x 5 Ctn)

3M Scotch-Brite Berus Hijau 5 Susun	S. Price
9557 90707 9222	RM 10.00/Set

35



3M3头青布 (Qty: 72 Set x 5 Ctn)

3M Scotch-Brite Berus Hijau 3 Susun	S. Price
9557 90706 7588	RM 3.20/Set

21-3M



10



3M 四头海棉青布 (Qty: 12 Set x 10 Ctn)

3M Scotch-Brite Span Kahwin 4 Pcs/Set	S. Price
8859 27220 1477	RM 10.00/Set

40



3M 五头海棉青布 (Qty: 24 Set x 5 Ctn)

3M Scotch-Brite Span Kahwin 5 Pcs/Set	S. Price
9557 90707 9277	RM 10.00/Set

41



3M 排庄海棉青布 (Qty: 96 Pcs x 4 Ctn)

3M Scotch-Brite Span Kahwin Siap Papan	S. Price
4800 31400 9692	RM 3.00/Pcs

42



10



3M 排庄海绵青布

(Qty: 31 Pcs x 10 Papan)

3M Span Kahwin Siap Papan 31 Pcs	S. Price
8850 30400 0068	111.60/Ppn

36



泰国 排庄海绵青布

(Qty: 24 Pcs x 12 Papan)

Merry Brite Span Kahwin Besar Siap Papan 24 Pcs	S. Price
8851 70500 1104	36.00/Ppn

37



泰国 排庄海绵青布

(Qty: 24 Pcs x 12 Papan)

Merry Brite Span Kahwin Kecil Siap Papan 24 Pcs	S. Price
8851 70500 1076	22.80/Ppn

38



Merry 排庄海绵布 (Qty: 24 Pcs x 12 Papan)

Merry Span Kain Thai Siap Papan 24 Pcs	S. Price
8851 70500 1135	1.30/Pcs

39



10

两角海棉 (Qty: 36 Bks x 1 Ctn)

Span 30 Sen 48's	S. Price
9555 48350 0444	RM 16.00/Bks

1

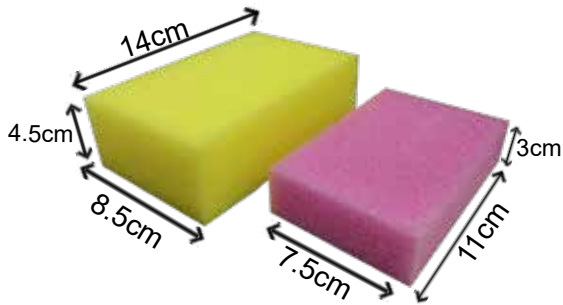

A1 海棉 (Qty: 20 Bks x 1 Ctn)

Span A1 48's	S. Price
9555 48351 0221	RM 39.00/Bks

2

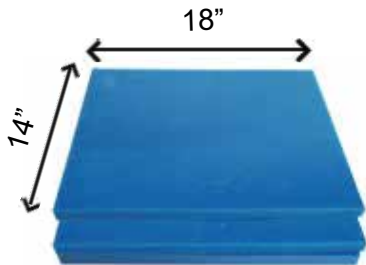

蓝五金海棉 (Qty : 2 Doz x 4 Bks)

Span Biru 24's	S. Price
14" x 18"	RM 60.00/Doz

3

三头海棉 (Qty: 24 Set x 24 Bks)

Span KIBI 0475 3 Pcs/Set	S. Price
9555 48350 0475	RM 1.80/Set

4



四头海棉 (Qty: 12 Set x 20 Bks)

Span 0482 4Pcs/Set	S. Price
9555 48350 0482	RM 4.60/Set

5

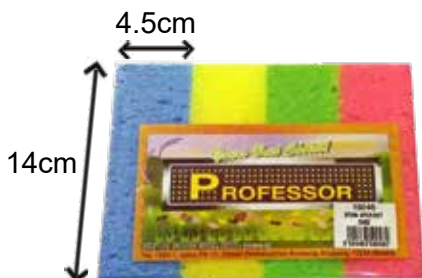

四头海棉青布 (Qty: 24 Set x 24 Bks)

Span Kahwin KIBI 0505 4Pcs/Set	S. Price
9555 48350 0505	RM 2.10/Set

8





10



四头刷洗大王 (120 Set x 2 Ctn)

Span Mas JAWS 1280 4 Pcs/Set	S. Price
~	3.20/Pcs

20

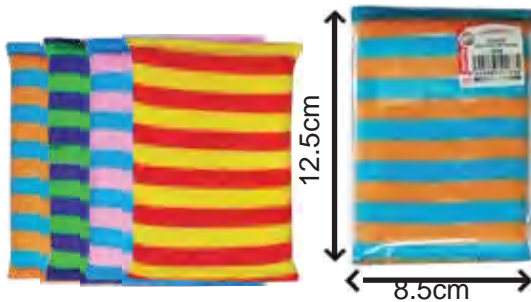

布海棉 (Qty: 60 Pcs x 12 Bks)

Span Kain Berbelang 1334	S. Price
~	0.95/Pcs

23



10



布海棉 (Qty: 60 Pcs x 20 Bks)

Span Kain 0543	S. Price
9555 48350 0543	RM 1.70/Pcs

13



八字形洗车海棉 (Qty: 12 Pcs x 20 Bks)

Span Cuci Kereta Bentuk 8	S. Price
9555 48350 0550	RM 4.00/Pcs

15



八字形布海棉 (Qty: 48 Pcs x 20 Bks)

Span Mandi Kain 0512	S. Price
9555 48350 0512	RM 3.20/Pcs

10



八字形冲凉海棉 (Qty: 24 Pcs x 30 Bks)

Span Mandi KIBI 0529	S. Price
9555 48350 0529	RM 1.70/Pcs

11



10



50克±桶装沐浴网 72's (Qty: 5 Tin x 1 Ctn)

Span Mandi JAWS Silinder 50g	S. Price
9555 48351 1662	200.00/Tin

32



30克 芳香沐浴棉 (Qty: 2 Doz X 10 Papan)

Span Mandi Jaring JAWS	S. Price
30g (Kecil)	24.00/Doz
9555 48350 0659	

12



60克 芳香沐浴棉 (Qty: 1 Doz x 12 Bks)

Span Mandi Jaring JAWS	S. Price
60g± (Besar)	36.00/Doz
9555 48350 1397	

28



10



三头海藻棉青布 (Qty: 30 Set x 8 Bks)

Span Kahwin JAWS Taiwan 1730 3 Susun	S. Price
9555 48351 1730	3.00/Pcs

33



三头台湾海绵青 (Qty: 30 Set x 8 Bks)

Span Kahwin JAWS Taiwan 1747 3 Susun	S. Price
9555 48351 1747	4.00/Pcs

34



10

布咖啡滤



	Tapis Kopi Kain	S. Price	
12.5CM	Besar 大号 (9555 48350 1311) (Qty: 20 Doz x 1 Ctn)	RM 35.60/Doz	1
11.5CM	Kecil 小号 (9555 48350 1328) (Qty: 20 Doz x 1 Ctn)	RM 34.40/Doz	2
	Paling Besar 特大 (9555 48351 0405) (Qty: 10 Doz x 1 Ctn)	RM 46.00/Doz	39

尼龙咖啡滤



	Tapis Kopi Nylon	S. Price	
	Besar 大号 (9555 48351 1846) (Qty: 20 Doz x 1 Ctn)	RM 33.60/Doz	3
	Kecil 小号 (9555 48351 1853) (Qty: 20 Doz x 1 Ctn)	RM 31.20/Doz	4
	Paling Besar 特大 (9555 48351 0412) (Qty: 10 Doz x 1 Ctn)	RM 40.80/Doz	40



铜柄尼龙咖啡滤 (Qty: 10 Doz x 1 Ctn)

	Tapis Kopi Nylon Tangkai Tembaga	S. Price	
	9555 48351 1914	RM 90.00/Doz	5



10

原子咖啡濾



Tapis Plastik SS Bombay	Price	
002 - 7cm (9555483501786)	12.00/Doz	11
216 Doz x 1 Ctn		
003 - 9cm (9555483501793)	14.00/Doz	12
168 Doz x 1 Ctn		
004 - 10cm (9555483501809)	23.00/Doz	13
96 Doz x 1 Ctn		
005 - 13cm (9555483501816)	31.00/Doz	14
60 Doz x 1 Ctn		
006 - 15cm (9555483501823)	40.00/Doz	15
48 Doz x 1 Ctn		
007 - 18cm (9555483501830)	54.00/Doz	16
30 Doz x 1 Ctn		
008 - 21cm (9555483501847)	80.00/Doz	17
18 Doz x 1 Ctn		
240 - 28cm (9555483501854)	120.00/Doz	26
15 Doz x 1 Ctn		

原子咖啡濾 (Qty: 6 Doz x 1 Ctn)



Tapis Plastik Tinggi Bombay	Price	
005-T (9555 48351 0566)	39.60/Doz	36
006-T (9555 48351 0573)	45.00/Doz	37
007-T (9555 48351 0580)	56.00/Doz	38

捷克白鋼咖啡濾 (Qty: 6 Doz x 1 Ctn)



Tapis S/Steel Jetke	Price	
No.18 - 18cm	10.60/Pcs	21



10

米良椰漏 (Qty: 6 Doz x 1 Ctn)



Tapis Kelapa	S. Price
20cm	72.00/Doz
22cm	80.00/Doz
24cm	87.00/Doz

8
9
10



10



火种 (Qty: 1 Doz x 10 Bks)

Ubat Arang (AYAM)	S. Price
9555 12620 7082	83.00/Doz

1010



火种 (Qty: 1 Doz x 6 Bks)

Ubat Arang KIBI	S. Price
9555 48351 1174	63.60/Doz

10



万能瓜刨 (Qty: 10 Doz x 1 Ctn)

Sagat Plastik	S. Price
~	108.00/Doz

7



盒庄火炭 (Qty: 12 Ktk x 3 Peti)

Batu Arang KIBI ± 3Kg	S. Price
9555 48351 1372	17.80/Ktk

14



10



鱼锤 (Qty: 20 Pcs x 1 Ctn)

Tukul Potong Ikan	S. Price
9555 48351 0320	RM40.00/PCS

3



鱼刨 (Qty: 12 Doz x 1 Ctn)

Kupas Sisik Ikan	S. Price
Besar 大	39.60/Doz
Kecil 小	30.00/Doz

1

2



20

塑料拉带



Kabel Tie Putih (10 Pcs x 3 Bks)	S. Price
4" x 2.0mm - 9555483500710	RM1.70/PEK
6" x 2.5mm - 9555483500727	RM3.40/PEK
8" x 3.5mm - 9555483500734	RM6.20/PEK
10" x 5.0mm - 9555483500741	RM10.00/PEK
12" x 5.0mm - 9555483502072	RM11.20/PEK
8" x 3.0mm - 9555483502089	RM4.60/PEK

1
2
3
4
5
8

塑料拉带



Kabel Tie Hitam (10 Pcs x 3 Bks)	S. Price
4" x 2.0mm - 9555483512294	RM1.80/PEK
6" x 2.5mm - 9555483512256	RM3.70/PEK
8" x 3.5mm - 9555483512263	RM6.80/PEK
10" x 5.0mm - 9555483512270	RM11.00/PEK
12" x 5.0mm - 9555483512287	RM12.20/PEK
8" x 3.0mm - 9555483502089	RM4.80/PEK

1-HT
2-HT
3-HT
4-HT
5-HT
8-HT

幼扎带 (1000 Pcs x 5 Pek x 1 Box)



Kabel Tie Kasut Halus	S. Price
7"	RM27.20
9"	RM29.20

6
7



20



灯泡插头 (Qty: 24 Pcs x 50 Ktk)

Lamp Adaptor	S. Price
~	1.20/Pcs

1



悬吊式插口灯座 (Qty: 20 Pcs x 60 Ktk)

Lamp Holder	S. Price
~	1.25/Pcs

2



平装式螺口灯座 (Qty: 20 Pcs x 40 Ktk)

Lamp Holder Dinding Skru	S. Price
501	2.00/Pcs

5



悬吊式螺口灯座 (Qty: 40 Pcs x 30 Ktk)

Lamp Holder Skru	S. Price
502	2.00/Pcs

6



20



长灯 (Qty: 10 Peti X 30 Pcs)

Lampu Panjang Led 22W SUPA	S. Price
9555 48351 2355	8.60/Pcs

10



长灯 (Qty: 6 Peti X 30 Pcs)

Lampu Panjang LED 30W SUPA	S. Price
9555 48351 2348	12.80/Pcs

22



短灯 (Qty: 6 Peti X 30 Pcs)

Lampu Pendek LED 10W SUPA	S. Price
9555 48351 2331	8.00/Pcs

25



长灯 (Qty: 10 Peti X 30 Pcs)

Lampu Panjang LED 20W SUPA	S. Price
9555 48351 2362	7.50/Pcs

26



SIN TAI SOON SDN. BHD. (116948-X)

新大順貿易有限公司

06

20



飞利灯 (Qty:30pcs x 10 Ctn)

Lampu Philip	S. Price
Panjang 长	RM13.40/PCS
Pendek 短	RM13.40/PCS

3
4



SIN TAI SOON SDN. BHD. (116948-X)

新大順貿易有限公司

09

20



启动器 (Qty: 25 Pcs X 40 Ktk)

Starter EURO LIGHT S-10	S. Price
~	RM 1.10/Pcs

1



20



短灯架 (Qty: 2 Peti X 60 Pcs)

Rumah Lampu Pendek LED 1.5cm X 3cm Siap Wire	S. Price
9555 48351 2324	5.40/Pcs

24

长灯架 (Qty: 2 Peti X 60 Pcs)

Rumah Lampu Panjang LED 1.5cm X 3cm Siap Wire	S. Price
9555 48351 2317	6.00/Pcs

23

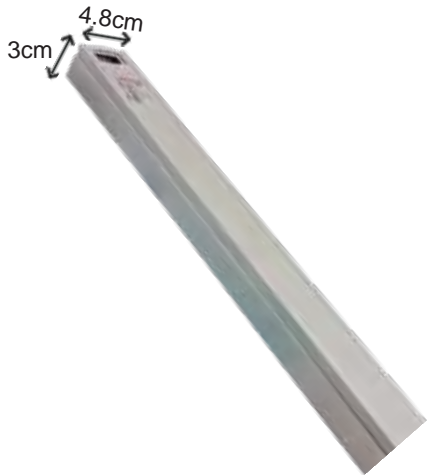

长灯架 (Qty: 4 Peti X 30 Pcs)

Rumah Lampu Panjang LED 3cm X 4.8cm Siap Wire	S. Price
9555 48351 1990	9.20/Pcs

27



20



万能插头 (Qty: 12 Pcs x 20 Ktk)

Multi Plug	Cost
~	4.00/Pcs

1



重型标签插头

3 Way Adaptor	S. Price
UK (Qty: 12 Pcs x 20 Ktk)	4.50/Pcs
9555 48350 2110	
Sirim (Qty: 10 Pcs x 20 Ktk)	9.60/Pcs
9555 48350 2264	

2

3



重型标签插头 (Qty: 100 Pcs X 1 Ctn)

3 Way Adaptor SIRIM GL313	S.Price
3390 99336 6786	12.00/Pcs

19



20



透明灯泡 (Qty: 10 Bks x 10 Pcs)

Mentol SUPA Clear PS60 B22	S. Price
60 Watt - 9555 48351 0047	RM 4.00/Pcs
100 Watt - 9555 48351 0054	RM 4.00/Pcs

3-S

4-S



沙蒙灯泡 (Qty: 10 Bks x 10 Pcs)

Mentol SUPA Frosted PS60 B22	S. Price
60 Watt - 9555 48351 0061	RM 4.00/Pcs
100 Watt - 9555 48351 0078	RM 4.00/Pcs

7-S

8-S



沙蒙灯泡 (Qty: 10 Bks x 10 Pcs)

Mentol SUPA Skru PS60 E27	S. Price
60 Watt - 9555 48351 0085	RM 4.00/Pcs
100 Watt - 9555 48351 0092	RM 4.00/Pcs

10-S

11-S



20



五瓦特灯泡 (Qty: 25 Pcs x 20 Ktk)

Mentol Color 5 Watt Chiyoda	S. Price
Transparent 透明	RM2.20/Pcs
Biru 蓝	RM2.20/Pcs
Hijau 青	RM2.20/Pcs
Kuning 黄	RM2.20/Pcs
Merah 红	RM2.20/Pcs

23

24

25

26

27



透明灯泡 Qty/Ctn: 100 Pcs x 1 Ctn

Mentol CHIYODA Runcing Clear 25 Watt C35 E14	Cost	S. Price
~		4.20/PCS

49



透明灯泡 Qty/Ctn: 100 Pcs x 1 Ctn

Mentol CHIYODA Runcing Clear 25 Watt C35 E27 220	Cost	S. Price
~		4.20/PCS

50





20



节能灯 (Qty: 10 Pcs x 10 Ktk)

PANASONIC Mentol 3U	S. Price
18W - E27	17.80/Pcs

47



节能灯 (Qty: 12 Pcs x 8 Ktk)

PANASONIC Mentol Spiral	S. Price
25W - E27	25.70/Pcs

48



SIN TAI SOON SDN. BHD. (116948-X)

新大順貿易有限公司

08

20



三脚插头 (Qty: 20 Pcs x 20 Ktk)

Plug Top Tembaga SIRIM	S.Price
9555 48350 2103	3.40/Pcs

4



SIN TAI SOON SDN. BHD. (116948-X)

新大順貿易有限公司

10

20



开关 (Qty: 10 Pcs x 20 Ktk)

Suis	S. Price
Single 单	3.60/Pcs

1

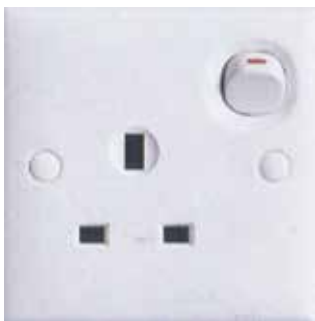

插座 (Qty: 10 Pcs x 20 Ktk)

Suis Socket	S. Price
Sirim 标签	3.60/Pcs

3



SIN TAI SOON SDN. BHD. (116948-X)

新大順貿易有限公司

11

20



红黑铜电线 20Pcs x 1 CTN

Wire Hitam / Merah Tembaga	S. Price
~	RM38.00/PCS

4



SIN TAI SOON SDN. BHD. (116948-X)

新大順貿易有限公司

200

20



试电笔

Test Pen	S. Price
Pendek	

5



30

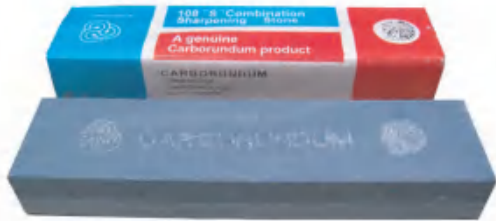

便宜山人刀石 (Qty: 50 Pcs x 1 Ctn)

Batu Asah Dayak Murah	Cost
6"	4.80/Pcs
8"	5.20/Pcs

1
2



好山人刀石 (Qty: 10 Pcs x 5 Ktk)

Batu Asah Dayak Baik	Cost
6"	12.80/Pcs
8"	14.800/Pcs

3
4

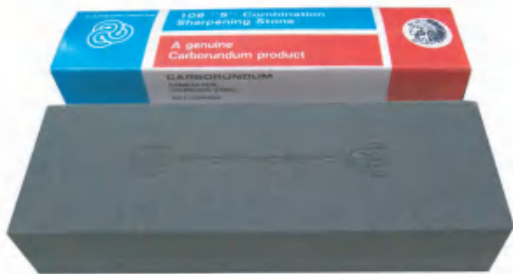

加大刀石 (Qty: 20 Pcs x 1 Ctn)

Batu Asah Tebal	Cost
2" x 3" 8"	32.00/Pcs

5



2寸老鹰标刀石 (Qty: 1 Doz x 10 Ktk)

2" Batu Asah Cap King Eagle	Cost
120	77.00/Doz
150	77.00/Doz
320	81.00/Doz
400	85.00/Doz
500	101.00/Doz
600	106.00/Doz

10
6
9
11
13
14



30



钻石标油石 (Qty: 50 Pcs x 1 Ctn)

Batu Asah Cap Diamond	S. Price
6"	RM 3.00/Pcs

16



1200 老鹰标滑石 (Qty: 12 Pcs x 10 Ktk)

Batu Asah Cap King Eagle	S.Price
~	RM 4.00/Pcs

22



正巴西双面刀石 (Qty: 10 Pcs x 5 Ktk)

LSBS Batu Asah Dayak Brazil	S. Price
6"	RM 30.00/Pcs
8"	RM 33.00/Pcs

25

26



棕油树双面刀石 (Qty: 10 Pcs x 5 Ktk)

Batu Asah Cap Kelapa Sawit	S. Price
6" - 9555 48350 3438	RM 14.60/Pcs
8" - 9555 48350 3445	RM 16.60/Pcs

27

28



棕油树双面刀石 (Qty: 20 Pcs x 1Ctn)

Batu Asah Cap Kelapa Sawit Tebal No.600	S.Price
8" x 3" x 2"	RM 160.00/Pcs
9555 48351 8586	

46



30



十二寸园草刀石 (Qty: 50 Pcs x 1 Ctn)

Batu Asah Bulat 12"	Cost
~	15.60/Pcs

18



2IN1 双用橡胶树刀石 (Qty: 10 Pcs x 10 Ktk)

Batu Asah Cap Pokok Getah 2 IN 1	S.Price
500 & 600 (9555 48351 8289)	RM 11.50/Pcs

47

橡胶树刀石 (Qty: 12 Pcs x 12 Ktk)

Batu Asah Cap Pokok Getah 8" X 2"	S.Price
120 (9555 48350 2684)	98.00/Doz
150 (9555 48350 2707)	98.00/Doz
320 (9555 48350 2721)	106.00/Doz
400 (9555 48350 2745)	110.00/Doz
500 (9555 48350 2769)	137.00/Doz
600 (9555 48350 2783)	143.00/Doz

34

35

36

37

38

39



Batu Asah Cap Pokok Getah 8" X 1.5"	S.Price
120 (9555 48350 2677)	87.00/Doz
150 (9555 48350 2691)	87.00/Doz
320 (9555 48350 2714)	98.00/Doz
400 (9555 48350 2738)	104.00/Doz
500 (9555 48350 2752)	128.00/Doz
600 (9555 48350 2776)	135.00/Doz

40

41

42

43

44

45





30

木工线 (Qty: 300 Pcs x 1 Ctn)



Benang Jala	S.Price
3	2.70/Pcs
6	2.70/Pcs
9	2.50/Pcs
12	2.50/Pcs
15	2.50/Pcs
18	2.50/Pcs
21	2.50/Pcs
4	2.70/Pcs

1
2
3
4
5
6
7
8



30



(Qty: 500 Pcs x 10tn)

Pen Dakwat Cina Tangkai Buluh	Cost
小楷笔 (S)	1.50/Pcs
大楷笔 (L)	1.60/Pcs

24
25

大楷笔 (Qty: 500 Pcs x 10tn)

Pen Dakwat Cina Tangkai Plastik	Cost
L 大	1.00/Pcs

38



30

漆扫



Berus Cat Baik (680)	S. Price
1" - 100 Doz x 1 Ctn	19.50/Doz
1 1/2" - 50 Doz x 1 Ctn	28.00/Doz
2" - 40 Doz x 1 Ctn	40.50/Doz
2 1/2" - 40 Doz x 1 Ctn	53.00/Doz
3" - 30 Doz x 1 Ctn	68.50/Doz
4" - 25 Doz x 1 Ctn	103.00/Doz

26

27

28

29

30

31



沙爹刷 (Qty: 20 Pcs x 5 Bks)

Berus Sate	S.Price
9555 48351 9057	3.30/Pcs

47



30

胶柄尼龙漆扫

Berus Cat Nylon (620)	S. Price	
1" - 1 Ctn x 60 Doz	RM 17.50/Doz	32
9555 48351 9101		
1 1/2" - 1 Ctn x 50 Doz	RM 24.50/Doz	33
9555 48351 9118		
2" - 1 Ctn x 50 Doz	RM 36.50/Doz	34
9555 48351 9125		
2 1/2" - 1 Ctn x 40 Doz	RM 51.50/Doz	35
9555 48351 9132		
3" - 1 Ctn x 30 Doz	RM 67.50/Doz	36
9555 48351 9149		
4" - 1 Ctn x 20 Doz	RM 96.50/Doz	37
9555 48351 9156		





30



米勾 (Qty: 2 Bks x 5 Pcs)

Cangkuk Guni	Price
12" - 9555 48351 2911	RM 9.50/Pcs
14" - 9555 48351 3062	RM 10.00/Pcs
16" - 9555 48351 2577	RM 10.50/Pcs
18" - 9555 48351 2935	RM 11.00/Pcs

1

2

3

4



-30%

货勾 (Qty: 200 Pcs x 1 Ctn)

Mata Cangkuk Besi 4" Tanpa Packing	Price
~	RM 3.00/Pcs

6



货勾 (卡装) (Qty: 12 Kad x 10 Bks)

Mata Cangkuk Besi 4" Berpacking	Price
(9555 48351 9736)	RM 4.30/Kad

8

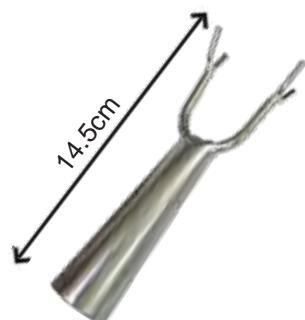

货勾 (Qty: 400 Pcs x 1 Ctn)

Mata Cangkuk Krom Besar 6" Tanpa Packing	Price
~	RM 3.70/Pcs

11



30

6.5cm



转环 (卡装)(Qty: 12 Kad x 12 Bks)

Cangkuk Bulat Berpusing No.6 (2 Pcs)	Price
9555 48351 8647	3.00/Kad

9

7cm



保险勾 (卡装)(Qty: 12 Kad x 12 Bks)

Cangkuk Rantai Haiwan 7cm (2 Pcs)	Price
9555 48351 8654	3.80/Kad

10



30



棕油树木柄锄头 (Qty: 5 Pcs x 10 Ctn)

Cangkul S/Steel Cap Kelapa Sawit No.3 Siap Batang Kayu	S. Price (RM)
9555 48351 8623	RM 33.00/Pcs

29

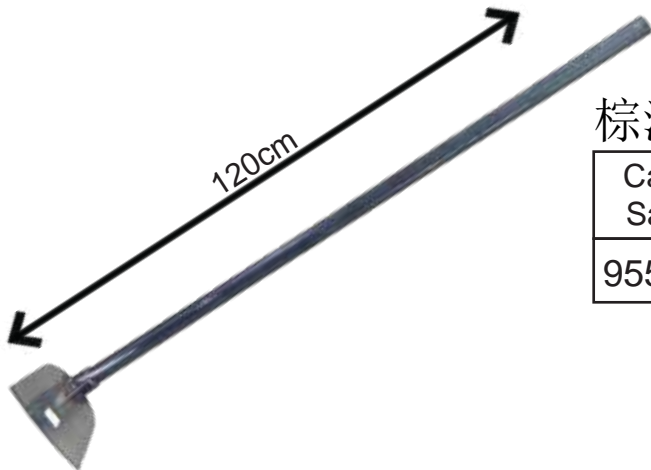

棕油树铁柄锄头 (Qty: 5 Pcs x 10 Ctn)

Cangkul S/Steel Cap Kelapa Sawit No.3 Siap Batang Besi	S. Price (RM)
9555 48351 2751	RM 44.00/Pcs

20

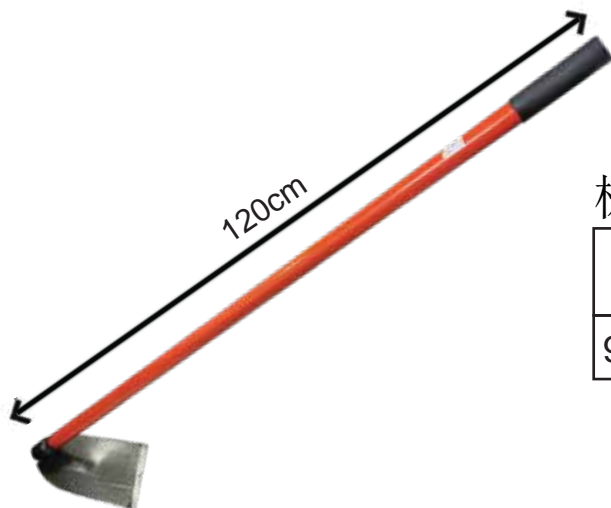

棕油树铁柄锄头 (Qty: 10 Pcs x 5 Ctn)

Cangkul S/Steel Cap Kelapa Sawit No.2 Siap Batang Besi	S. Price (RM)
9555 48351 8753	RM 28.00/Pcs

28

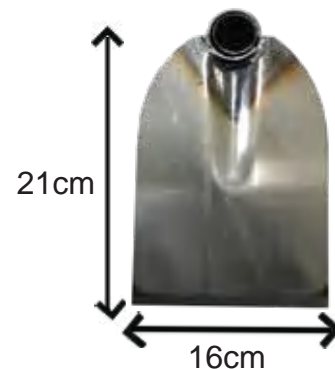



30



三大牌鋤頭 (2 Doz x 1 Ctn)

Cangkul	S. Price
No.2 - Cock Brand	260.00/Doz
No.3 - Cock Brand	270.00/Doz
No.4 - Cap Sunta	290.00/Doz

11

12

13



单柄铁铲 (Qty: 120 Pcs X 1 Ctn)

Penyodok Single Tangkai Besi 45cm 8814	S. Price
9555 48351 8814	8.00/Pcs

27



30



蓝色双用小锄头 (Qty: 10 Pcs x 6 Ikat)

Cangkul Dua Pakai Local	S. Price
9555 48351 8524	RM 19.60/Pcs

1



蓝色小锄头 (Qty: 10 Pcs x 6 Ikat)

Cangkul Kecil Local	S. Price
9555 48351 8531	RM 12.00/Pcs

2



油棕树钢柄小锄头 (Qty: 60 Pcs x 10ctn)

Cangkul Kecil S/Steel Cap Kelapa Sawit 2744	S. Price
9555 48351 2744	RM 12.00/Pcs

21



双用小锄头 (Qty: 60 Pcs x 1 Ctn)

Cangkul Kecil Dua Pakai 2577	S. Price
9555 48351 2577	RM 11.00/Pcs

22



30

锄头 (蓝色) (Qty: 10 Pcs x 6 Ikat)

Cangkul Biru	S. Price
Besar (大) 9555 48351 2515	RM 25.00/Pcs
Sedang (中) 9555 48351 2522	RM 23.20/Pcs

4-B
5-B



水沟锄头 (蓝色) (Qty: 10 Pcs x 6 Ikat)

Cangkul Longkang Biru	S. Price
9555 48351 2539	RM 22.00/Pcs

6-B

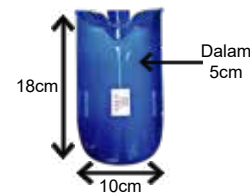

加大水沟锄头 (蓝色) (Qty: 10 Pcs x 6 Ikat)

Cangkul Longkang Biru Besar Berlubang	S. Price
Tanpa Kayu - 9555 48351 8272	RM 21.00/Pcs
Siap Kayu	RM 29.50/Pcs

6600
6300

水沟锄头45° (蓝色) (Qty: 10 Pcs x 6 Ikat)

Cangkul Longkang Biru 45°	S. Price
9555 48350 0222	RM 23.20/Pcs

23

水沟锄头45° (蓝色) (Qty: 10 Pcs x 6 Ikat)

Cangkul Longkang Biru 45° Besar	S. Price
Tanpa Kayu - 9555 48351 8197	RM 21.00/Pcs
Siap Kayu	RM 29.50/Pcs

23600
23300

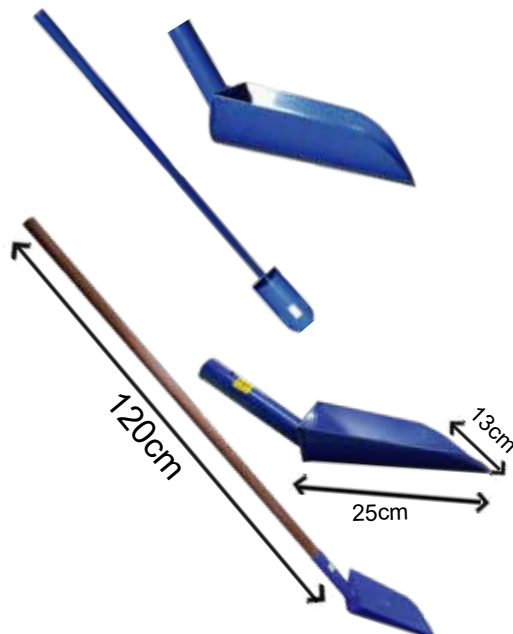
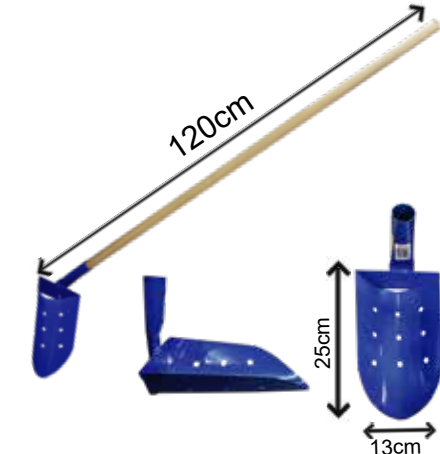
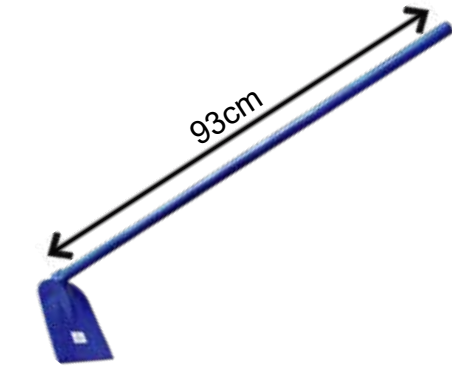



30

噴漆



BUY 10 DOZ - FOC 1 DOZ
BUY 20 DOZ - FOC 3 DOZ

JIKA WARNA YG DI MINTA
TIDAK CUKUP ATAU
TIADA STOCK,
KAMI AKAN GANTIKAN
DENGAN WARNA HITAM
ATAU WARNA-WARNA LAIN
YG MASIH ADA.

如果订购之颜色不足
或无货。则以黑色或
现存之颜色取代

Cat Spray		S. Price	
KRYSTAL Clear	01	RM 88.20/Doz	16-01
KRYSTAL White	02	RM 88.20/Doz	16-02
KRYSTAL Flat Clear	F1	RM 88.20/Doz	16-F1
KRYSTAL Flat White	F2	RM 88.20/Doz	16-F2
KRYSTAL Silver	03	RM 88.20/Doz	16-03
KRYSTAL Gold	08	RM 88.20/Doz	16-08
KRYSTAL Yellow	12	RM 88.20/Doz	16-12
KRYSTAL Orange	14	RM 88.20/Doz	16-14
KRYSTAL Vermillion	15	RM 88.20/Doz	16-15
KRYSTAL Pink	18	RM 88.20/Doz	16-18
KRYSTAL Red Oxide	19	RM 88.20/Doz	16-19
KRYSTAL Monsa Red	20	RM 88.20/Doz	16-20
KRYSTAL Crystal Blue	21	RM 88.20/Doz	16-21
KRYSTAL Oxford Blue	22	RM 88.20/Doz	16-22
KRYSTAL Blue	23	RM 88.20/Doz	16-23
KRYSTAL Felt Green	24	RM 88.20/Doz	16-24
KRYSTAL Grey	25	RM 88.20/Doz	16-25
KRYSTAL Deep Green	27	RM 88.20/Doz	16-27
KRYSTAL Flat Black	29	RM 88.20/Doz	16-29
KRYSTAL Black	30	RM 88.20/Doz	16-30
KRYSTAL Fresh Green	31	RM 88.20/Doz	16-31
KRYSTAL Red	33	RM 88.20/Doz	16-33
KRYSTAL Dark Blue	34	RM 88.20/Doz	16-34
KRYSTAL Dark Grey	35	RM 88.20/Doz	16-35
KRYSTAL Chrome Yellow	36	RM 88.20/Doz	16-36
KRYSTAL Light Blue	37	RM 88.20/Doz	16-37
KRYSTAL Mahagony	60	RM 88.20/Doz	16-60
KRYSTAL Petronas Green	62	RM 88.20/Doz	16-62



SIN TAI SOON SDN. BHD. (116948-X)

新大順貿易有限公司

07

30



加柄油子乍 (Qty: 5 Pcs x 4 Ikat)

Chop Buah Bertangkai (2.5kg)	S. Price
4 1/2" (9555 48351 3079)	43.00/Pcs

1



SIN TAI SOON SDN. BHD. (116948-X)

新大順貿易有限公司

40

30



马里乍 (Qty: 5 Pcs x 4 Ctn)

Penggali (2.0kg)	S. Price
9555 48351 3109	38.00/Pcs

1



30



T型尖黑油子乍 (Qty: 20 Pcs x 1 Ctn)

Chop Buah Tajam Hitam Tangkai Bentuk T	S. Price
~	22.00/Pcs

6



T型尖电度油子乍 (Qty: 20 Pcs x 1 Ctn)

Chop Buah Tajam G/I Paip Tangkai Bentuk T	S. Price
~	30.00/Pcs

7



D型尖电度油子乍 (Qty: 20 Pcs x 1 Ctn)

Chop Buah Tajam Hitam Tangkai Bentuk D	S. Price
~	28.00/Pcs

10



D型尖电度油子乍 (Qty: 20 Pcs x 1 Ctn)

Chop Buah Tajam G/I Paip Tangkai Bentuk D	S. Price
~	35.00/Pcs

11



SIN TAI SOON SDN. BHD. (116948-X)

新大順貿易有限公司

08

30



幼铁线 (Qty: 100 Pcs x 6 lkat x 1 Ctn)

Dawai Halus	S. Price
9555 48351 4878	0.58/Pcs

1



粗铁线 (Qty: 50 Pcs x 6 lkat x 1 Ctn)

Dawai Kasar	S. Price
9555 48351 4786	2.00/Pcs

2



青铁线 (Qty: 20 Pcs x 6 lkat x 1 Ctn)

Dawai Hijau	S. Price
9555 48351 4748	3.30/Pcs

4



包胶铁线 (Qty: 20Pcs x 12 Bks)

Dawai Bunga GX-014	S. Price
1.8mm X 15 Meter	4.00/Pcs
9555 48350 3353	

11



SIN TAI SOON SDN. BHD. (116948-X)

新大順貿易有限公司

08

30



电镀四叉勾 (Qty: 40 Box x 1 Ctn)

Dawai Langsir Crome 8430	S. Price
	14.40/Box

6



30



铁锯架(Qty: 12 Pcs x 4 Ktk)

Bingkai Gergaji Besi 12"	S. Price
9555 48351 2386	8.60/Pcs

1



迷你锯 (Qty: 12 Pcs x 25 Bks)

Gergaji Mini	S. Price
9555 48351 2997	4.00/Pcs

9



铁锯架(Qty: 24 Pcs x 1 Peti)

Gergaji Pokok Bentuk D 24"	S. Price
9555 48351 4984	13.80/Pcs

10

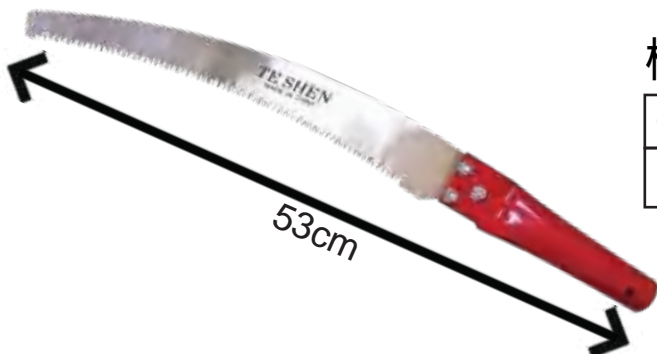

树枝锯 (Qty: 100 Pcs x 1 Ctn)

Gergaji Dahan	S. Price
9555 48351 2966	12.80/Pcs

11



30



有线煤气喉 (Qty: 10 Pcs x 10 Ikat)

Gas Paip Siap	S.Price
1.5 Meter	4.80/Pcs

1



煤气喉 (Qty: 5 Pcs x 1 Ctn)

Gas Paip Berjaring Professor	S.Price
30 Meter - 9555 48350 3650	84.00/Pcs
45 Meter - 9555 48351 4038	110.00/Pcs

25

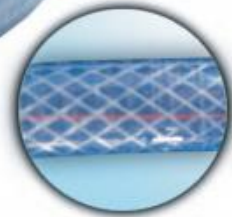



30

人造生胶喉 (Qty: 5 Pcs x 4 Ctn)



Getah Paip Oren E7	S. Price
5 Meter	13.60/Pcs
9555 48350 3551	
10 Meter	21.70/Pcs
9555 48350 3544	
15 Meter	31.00/Pcs
9555 48350 3568	
20 Meter	41.00/Pcs
9555 48350 3575	
30 Meter	56.60/Pcs
9555 48350 3582	

7

8

9

10

11

2mm

原装生胶喉 (Qty: 5 Pcs x 4 Ctn)



Getah Paip Oren Rubberex	S. Price
5 Meter	20.80/Pcs
9555 48350 3599	
10 Meter	36.00/Pcs
9555 48350 3605	
15 Meter	52.00/Pcs
9555 48350 3612	
20 Meter	69.00/Pcs
9555 48350 3629	
30 Meter	96.00/Pcs
9555 48350 3636	

34

35

36

37

38



30



脚车泵带 (Qty: 200 Pcs x 1 Ctn)

Getah Pam Basikal	S. Price
~	RM 3.60/Pcs

17



青色网喉

Getah Paip Hijau Berjaring	S. Price
5 Meter - 9555 48351 8425	RM 16.00/Pcs
1 Ctn x 10 Pcs	
10 Meter - 9555 48350 3537	RM 25.00/Pcs
1 Ctn x 10 Pcs	
15 Meter - 9555 48351 4885	RM 36.50/Pcs
1 Ctn x 10 Pcs	
30 Meter - 9555 48350 3643	RM 70.00/Pcs
1 Ctn x 10 Pcs	

45

15

44

16



锯子 (Qty: 60 Pcs x 1 Ctn)

Gergaji Papan	S. Price
18" (9555 48351 9941)	16.00/Pcs
20" (9555 48351 9958)	17.00/Pcs
22" (9555 48351 9774)	19.00/Pcs

3

4

5



30

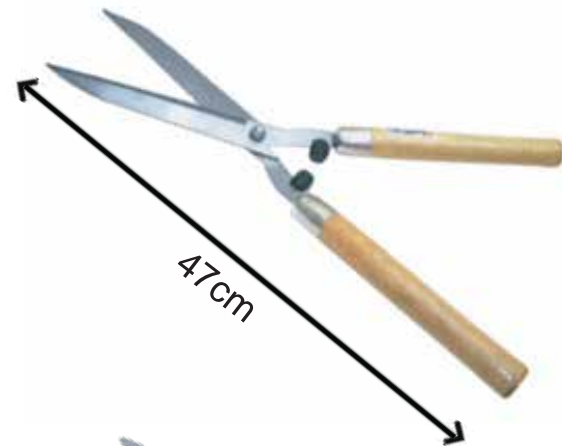

中国木柄篱笆剪刀 (Qty: 40 Pcs x 1 Ctn)

Gunting Pagar Cina Tangkai Kayu	S. Price
9555 48351 4045	RM 13.60/Pcs

1



油棕牌木柄篱笆剪刀 (Qty: 24 Pcs x 1 Ctn)

Gunting Pagar Cap Kelapa Sawit 3918	S. Price
9555 48351 3918	RM 27.50/Pcs

10



油棕牌篱笆剪刀 (Qty: 24 Pcs x 1 Ctn)

Gunting Pagar Cap Kelapa Sawit 2850	S. Price
9555 48351 2850	RM 26.00/Pcs

12



油棕牌篱笆剪刀 (Qty: 24 Pcs x 1 Ctn)

Gunting Pagar Cap Kelapa Sawit 8739	S. Price
9555 48351 8739	RM 30.00/Pcs

15



30



伸缩柄篱笆剪刀 (Qty: 24 Pcs x 1 Ctn)

Gunting Pagar Adjustable 2447	S. Price
9555 48351 2447	RM34.00

13



30

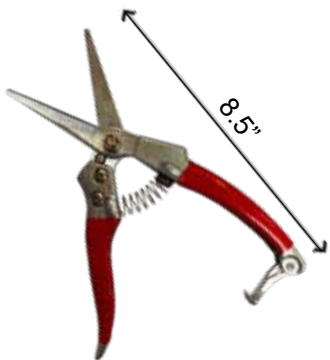

尖头剪支剪 (Qty: 12 Pcs x 5 Ktk)

Gunting Koko Tajam SUPA 8692	S. Price
8.5"-9555 48351 8692	RM 22.80/Pcs

16

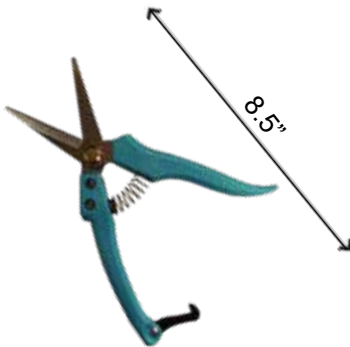

尖头剪支剪 (Qty: 12 Pcs x 5 Ktk)

Gunting Koko Tajam SUPA 8708	S. Price
8.5"-9555 48351 8708	RM 15.00/Pcs

17

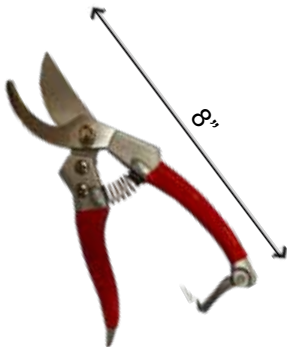

斜头剪支剪 (Qty: 12 Pcs x 5 Ktk)

Gunting Koko Muncung SUPA 8715	S. Price
8"-9555 48351 8715	RM 22.80/Pcs

18

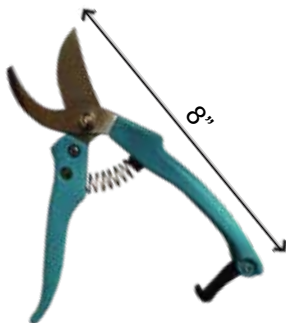

斜头剪支剪 (Qty: 12 Pcs x 5 Ktk)

Gunting Koko Muncung SUPA 8722	S. Price
8"-9555 48351 8722	RM 15.00/Pcs

19

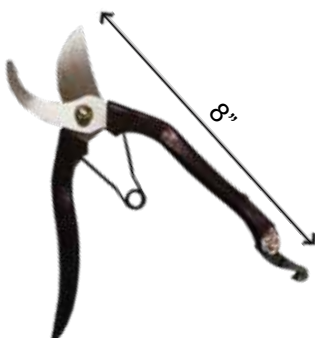

斜头剪支剪 (Qty: 12 Pcs x 5 Ktk)

Gunting Koko Muncung SUPA 8241	S. Price
8"-9555 48351 8241	RM 14.00/Pcs

20



SIN TAI SOON SDN. BHD. (116948-X)

新大順貿易有限公司

15

30



8"

尖头剪支剪 (Qty: 12 Pcs x 10 Ktk)

Gunting Koko Tajam 8838	S. Price
9555 48351 8838	11.00/Pcs

3



8"

斜头剪支剪 (Qty: 12 Pcs x 10 Ktk)

Gunting Koko Muncung 8821	S. Price
9555 48351 8821	11.00/Pcs

14



单头本地红毛丹剪 (Qty: 60 Pcs x 1 Ctn)

Gunting Rambutan Local GT 148	S.Price
9555 48351 9828	15.60/Pcs

9



双头红毛丹剪 (Qty: 60 Pcs x 1 Ctn)

Gunting Rambutan Double	S. Price
9555 48350 3049	18.00/Pcs

6



SIN TAI SOON SDN. BHD. (116948-X)

新大順貿易有限公司

16

30



高级菲巴铁锤 (Qty: 12 Pcs x 4 Ktk)

Hammer Tangkai Fibre SUPA 27mm	S.Price
9555 48350 3025	15.60/Pcs

2



SIN TAI SOON SDN. BHD. (116948-X)

新大順貿易有限公司

17

30

七彩锁牌



Ibu Kunci Tebal Mas	S. Price
65mm - (1 Ctn x 50 Doz)	19.60/Doz
85mm - (1 Ctn x 40 Doz)	28.00/Doz
115mm - (1 Ctn x 20 Doz)	39.20/Doz

9

10

11



SIN TAI SOON SDN. BHD. (116948-X)

新大順貿易有限公司

18

30

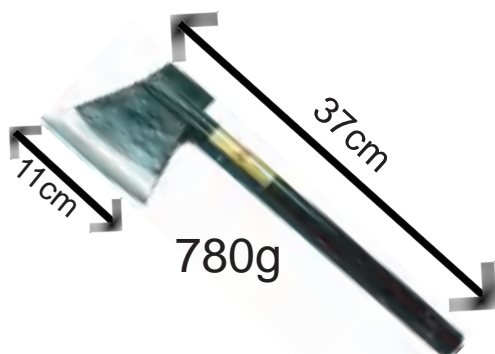

泰国铁柄斧头 (Qty: 5 Pcs x 8 Ikat)

Kapak Besi Thailand	S.Price
9555 48351 3444	34.00/Pcs

3



棕油树铁柄斧头 (Qty: 1 Ctn x 40 Pcs)

Kapak Cap Kelapa Sawit	S.Price
9555 48351 2768	31.00/Pcs

4



30

黑色水鞋 (Qty : 1 Ctn x 50 Psg)



Kasut Air Korakoh 6000#	S. Price
38/5	RM 16.30/Psg
39/6	RM 16.30/Psg
40/7	RM 16.30/Psg
41/8	RM 16.30/Psg
42/9	RM 16.30/Psg
43/10	RM 16.30/Psg
44/11	RM 18.30/Psg

1
18
19
20
21
22
64

黄色水鞋 (Qty: 1 Ctn X 12 Psg)



Kasut Air KORAKOH 7000#	S. Price
38/5	RM 35.00/Psg
39/6	RM 35.00/Psg
40/7	RM 35.00/Psg
41/8	RM 35.00/Psg
42/9	RM 35.00/Psg
43/10	RM 35.00/Psg
44/11	RM 36.80/Psg

23-K
24-K
25-K
26-K
27-K
28-K
63-K

米彩水鞋 (Qty: 1 Ctn X 12 Psg)



Kasut Air KORAKOH 7000# (ASKAR)	S. Price
38/5	RM42.00/Psg
39/6	RM42.00/Psg
40/7	RM42.00/Psg
41/8	RM42.00/Psg
42/9	RM42.00/Psg
43/10	RM42.00/Psg

23-KEM
24-KEM
25-KEM
26-KEM
27-KEM
28-KEM



30

褐紅色水鞋 (Qty/Ctn: 1 Ctn x 20 Psg)



Kasut Air Korakoh 9000# (MAROON)	S. Price	
38/5	20.70/Psg	52
39/6	20.70/Psg	53
40/7	20.70/Psg	54
41/8	20.70/Psg	55
42/9	20.70/Psg	56
43/10	20.70/Psg	57



30

塑料网 (Qty: 6 Roll x 1 Ctn)

Kawat Jaring PVC Thailand 1 Meter X 25 Meter	S. Price
6mm - 4 SEGI Hijau 青色	RM 180.00/Roll
6mm - 4 SEGI Hitam 黑色	RM 180.00/Roll
15mm - 4 SEGI Hijau 青色	RM 180.00/Roll
15mm - 4 SEGI Hitam 黑色	RM 180.00/Roll
6mm - HEXAGON Hijau 青色	RM 180.00/Roll
6mm - HEXAGON Hitam 青色	RM 180.00/Roll
15mm - HEXAGON Hijau 青色	RM 180.00/Roll
15mm - HEXAGON Hitam 青色	RM 180.00/Roll

13-HJ

13-HT

12-HJ

12-HT

26-HJ

26-HT

27-HJ

27-HT

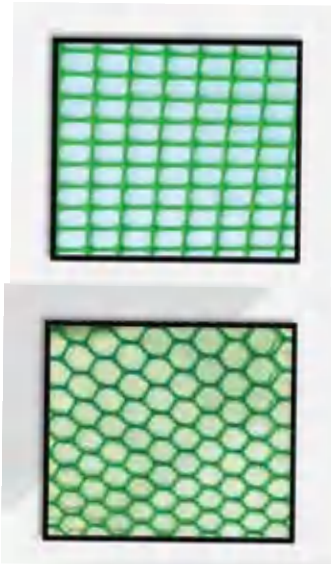

青色塑料蚊网 (Qty: 6 Roll x 1 Ctn)

Jaring Nyamuk PVC Hijau Thailand	S. Price
4 Kaki x 80 Kaki	RM 180.00/Roll

25





30



套压煤气头 (Qty: 30 Set x 1 Ctn)

Kepala Gas Set	S. Price
9555 48351 3208	RM 24.00/Set

1



煤气头 (Qty: 50 Pcs x 1 Ctn)

Kepala Gas MILUX	S. Price
~	RM 20.00/Pcs

2



高压煤气头 (Qty: 50 Pcs x 1 Ctn)

Kepala Gas High Pressure	S. Price
~	RM 37.00/Pcs

3



有线煤气喉甲夹 (Qty: 60 Set x 1 Ctn)

Gas Paip 1.5 Meter Siap Klip	S. Price
9555 48351 3550	RM 6.00/Set

5



30



一字塑胶水龙头 (Qty: 50 Pcs x 8 Bks)

Kepala Paip PVC (-)	S. Price
9555 48350 3414	RM 2.20/Pcs

1



饮水机水龙头 (Qty: 50 Pcs x 4 Bks)

Kepala Paip Bekas Air Minuman 3338	S. Price
9555 48351 3338	RM 3.00/Pcs

2



饮水机水龙头 (Qty: 50 Pcs x 4 Bks)

Kepala Paip Bekas Air Minuman 8449	S. Price
9555 48351 8449	RM 3.00/Pcs

56



30



铜龙头 (Qty: 10 Pcs x 10 Ktk)

Kepala Paip Tembaga 1/2"	S. Price
Kecil 轻型	16.60/Pcs

6



手推铜洗衣机龙头 (Qty: 12 Pcs x 10 Ktk)

Kepala Paip Tembaga Mesin Basuh Baju Italy Tanpa Packing	S. Price
1/2"	18.50/Pcs

3



30



1/2" 铜洗衣机龙头(-) (卡装) (Qty:12 Kad x 6 Bks)

Kepala Paip Tembaga Mesin Basuh Baju Berpacking 1/2"(-) 2553	S. Price
9555 48351 2553	20.50/Pcs

39



1/2" 铜轻型龙头 (卡装) (Qty: 10 Pcs x 6 Bks)

Kepala Paip Tembaga Kecil Berpacking 1/2" 2430	S. Price
9555 48351 2430	19.00/Pcs

40



1/2" 铜洗衣机龙头 (卡装) (Qty: 10 Pcs x 6 Bks)

Kepala Paip Tembaga Mesin Basuh Baju Berpacking 2423	S. Price
9555 48351 2423	27.80/Pcs

41



30



十字塑胶水龙头 (Qty: 50 Pcs x 8 Bks)

Kepala Paip PVC 3957 (+)	Cost
9555 48350 3957	2.40/Pcs

20



白色塑胶水龙头SUPA (Qty: 12 Pcs x 10 Bks)

Kepala Paip Bulat PVC SUPA (3964) ABS	Cost
9555 48350 3964	5.30/Pcs

21



洗脸盆水龙头SUPA (Qty: 6 Pcs x 9 Bks)

Kepala Paip Sinki PVC SUPA (3971) ABS	Cost
9555 48350 3971	9.70/Pcs

22



30



塑胶水龙头SUPA (Qty: 12 Pcs x 10 Bks)

Kepala Paip PVC SUPA 3949	S. Price
9555 48351 3949	RM 3.40/Pcs

26



手推钥匙龙头 (Qty: 12 Pcs x 6 Bks)

Kepala Paip PVC 2690 Berpacking	S. Price
9555 48351 2690	RM 2.50/Pcs

38



手推塑料体铁罗牙龙头 (Qty: 12 Pcs x 10 Bks)

Kepala Paip Plastik Tolak 8432	S. Price
9555 48351 8432	RM 4.40/Pcs

57



30



直出鹅颈水龙头SUPA (Qty: 6 Pcs x 6 Bks)

Kepala Paip Leher Lurus PUTIH SUPA (8007) ABS	S. Price
9555 48350 3988	19.60/Pcs

23



墙出鹅颈水龙头SUPA (Qty: 6 Pcs x 6 Bks)

Kepala Paip Leher Keluar Dinding PUTIH SUPA (8008) ABS	S. Price
9555 48350 3995	19.00/Pcs

24



手推柄直出鹅颈水龙头SUPA (Qty: 6 Pcs x 6 Bks)

Kepala Paip Leher Lurus SUPA PUTIH (4489) ABS	S. Price
9555 48351 4489	19.60/Pcs

33



手推柄墙出鹅颈水龙头SUPA (Qty: 6 Pcs x 6 Bks)

Kepala Paip Leher Keluar Dinding SUPA PUTIH (4496) ABS	S. Price
9555 48351 4496	19.00/Pcs

34



30



直出鹅颈水龙头SUPA (Qty: 6 Pcs x 6 Bks)

Kepala Paip Leher Lurus SUPA KROM (3970)	S.Price
955 548351 3970	18.60/Pcs

29



墙出鹅颈水龙头SUPA (Qty: 6 Pcs x 6 Bks)

Kepala Paip Leher Keluar Dinding SUPA KROM (3987)	S.Price
955 548351 3987	17.50/Pcs

30



30

水沙紙 (Qty: 100 Pcs x 1 Bks)



Kertas Pasir KOREA	S. Price	
80	0.86/Pcs	43
100	0.86/Pcs	38
120	0.86/Pcs	44
150	0.86/Pcs	39
180	0.86/Pcs	46
240	0.86/Pcs	40
320	0.86/Pcs	41
400	0.86/Pcs	23
500	0.86/Pcs	42
600	0.86/Pcs	24
800	0.86/Pcs	45
1000	0.86/Pcs	19
1200	0.86/Pcs	20
1500	0.86/Pcs	21
2000	0.86/Pcs	22



30

水沙紙 (Qty: 200 Pcs x 1 Bks)



Kertas Pasir	S. Price
80	0.64/Pcs
120	0.60/Pcs
150	0.60/Pcs
180	0.60/Pcs
240	0.60/Pcs
280	0.60/Pcs
320	0.60/Pcs
360	0.60/Pcs
400	0.60/Pcs
500	0.60/Pcs
600	0.60/Pcs
1000	0.60/Pcs

1
3
4
5
8
10
12
37
14
15
16
17



30

水沙紙(Qty: 10 Set x 6 Bks)



Kertas Pasir 3 Pcs/Set	S. Price	
80(9555 48351 9712)	2.90/Set	25
120 (9555 48351 9705)	2.90/Set	26
150 (9555 48351 9699)	2.90/Set	27
180 (9555 48351 9682)	2.90/Set	28
240 (9555 48351 9675)	2.90/Set	29
280 (9555 48351 9668)	2.90/Set	30
320 (9555 48351 9651)	2.90/Set	31
360 (9555 48351 9552)	2.90/Set	36
400 (9555 48351 9644)	2.90/Set	32
500 (9555 48351 9637)	2.90/Set	33
600 (9555 48351 9620)	2.90/Set	34
1000 (9555 48351 9613)	2.90/Set	35



30

帐篷 (Qty: 10 Set x 1 Ctn) (15kg/Set)



Canopy Tangkai Hitam	S. Price
3 Meter x 3 Meter	RM 270.00/Set
9555 48351 8296	

22

黑金钢帐篷 (Qty: 10 Set x 1 Ctn) (18kg/Set)

Canopy Tangkai Hitam Tebal	S. Price
3 Meter x 3 Meter	RM 300.00/Set
9555 48351 8302	

25

帐篷顶布 (Qty: 10 pcs x 1 Ctn)



Kain Canopy BIRU Bersalut	S. Price
3 Meter x 3 Meter 600D	RM 96.00/Set
9555 48351 2683	
3 Meter x 3 Meter 600D	RM 96.00/Set
9555 48351 9897	

37-B

37-M

帐篷顶布 (Qty: 5 pcs x 1 Ctn)



Kain Canopy Bersalut	S. Price
3 Meter x 4.5 Meter 600D	RM 120.00/Set
9555 48351 9866	
3 Meter x 4.5 Meter 600D	RM 120.00/Set
9555 48351 9873	

34-B

34-M

30251	25 Pcs	Size: 6' x 6'	9 555483 518456
30257	20 Pcs	Size: 6' x 9'	9 555483 502554
302514	25 Pcs	Size: 6' x 12'	9 555483 518470
30258	20 Pcs	Size: 7' x 10'	9 555483 502271
302532	20 Pcs	Size: 8' x 10'	9 555483 502288
30259	20 Pcs	Size: 8' x 12'	9 555483 502561
302510	20 Pcs	Size: 9' x 12'	9 555483 502301
302530	15 Pcs	Size: 9' x 16'	9 555483 502639
30254	20 Pcs	Size: 10' x 10'	9 555483 518487
302528	12 Pcs	Size: 10' x 12'	9 555483 502578
30255	20 Pcs	Size: 10' x 15'	9 555483 518494



STS SUPA™

PE Tarpaulin Canvas Lipat



Sesuai bagi perbagai kegunaan untuk mengelak dari **Panas Matahari** dan **Hujan** seperti :

- ✔ Semasa mengubah suai rumah
- ✔ Membalut barangan pengangkutan
- ✔ Sebagai penutup kenderaan serta
- ✔ Aktiviti luar seperti perkhemahan



www.sintaisoon.com

Diedarkan oleh: SIN TAI SOON SDN BHD (116948-X)

30256	40 Pcs	Size: 12' x 12'	9 555483 518500
302517	40 Pcs	Size: 12' x 15'	9 555483 502585
302512	40 Pcs	Size: 12' x 18'	9 555483 518463
302533	40 Pcs	Size: 15' x 15'	9 555483 502295
302511	8 Pcs	Size: 15' x 18'	9 555483 502592
302529	6 Pcs	Size: 18' x 20'	9 555483 502608
302518	5 Pcs	Size: 18' x 24'	9 555483 502622
302519	5 Pcs	Size: 20' x 20'	9 555483 502615
302520	4 Pcs	Size: 20' x 30'	9 555483 500291
302535	3 Pcs	Size: 30' x 30'	9 555483 513598
302536	2 Pcs	Size: 40' x 40'	9 555483 513604



30



手转龙头夹 (Qty: 100 Pcs x 20 Ktk)

Klip Kepala Paip Tangan Tanpa Packing	S. Price
~	1.00/Pcs

4



手转高压喉夹 (Qty: 100 Pcs x 20 Ktk)

Klip Gas Tanpa Packing	S. Price
9555 48350 3001	0.36/Pcs

5



手转小喉夹

Klip Gas Tangan Orbit	S. Price
13 - 20 (100 Pcs x 20Ktk)	1.50/Pcs
16 - 22 (100 Pcs x 12Ktk)	1.70/Pcs

12

13



塑料手柄龙头夹 (Qty: 100 Pcs x 10 Ktk)

Klip Kepala Paip Tangkai Plastik (S/Steel)	S. Price
~	1.20/Pcs

23

Stainless Steel



30



油棕夹 (Qty: 200 Pcs x 3 Ctn)

Klip Kelapa Sawit Skru	S. Price
38mm	RM 3.00/Pcs
45mm	RM 3.30/Pcs

6

7



好油棕夹 (Qty: 200 Pcs x 1 Ctn)

Klip Sabit Professor	S. Price
38mm Baik	RM 2.00/Pcs

8



手转油棕夹 (Qty:120 Pcs x 2 Ctn)

Klip Kelapa Sawit Tangan AA	S. Price
38mm STS	RM 6.00/Pcs
45mm STS	RM 6.60/Pcs

20

29



30



喉夹 (Qty: 6 Box X 100 Pcs)

Klip ORBIT Tanpa Packing		S.Price
#0	16-22	RM 1.50/Pcs
#00	13-19	RM 1.30/Pcs

1
2

喉夹 (Qty: 6 Box X 50 Pcs)

Klip Orbit Tanpa Packing		S.Price
#2	40-55	RM 2.05/Pcs

14



手转高压喉夹 (Qty: 264 Kad x 1Ctn)

Klip Gas 3 Pcs	S.Price
9555 48351 4816	RM 2.00/Kad

21



手转龙头夹 (Qty: 264 Kad x 1Ctn)

Klip Kepala Paip Tangan SUPA 2 Pcs	S.Price
9555 48351 4823	RM 3.00/Kad

22



SIN TAI SOON SDN. BHD. (116948-X)

新大順貿易有限公司

27

30



塑料手柄龙头夹 (Qty: 264 Kad x 1 Ctn)

Klip Kepala Paip Tangkai Plastik Berpacking (S/Steel)	S.Price
9555 48351 4854	2.00/Kad

25



30



喉夹 (Qty: 12 Kad x 22 Bks)

Klip Kepala Paip #16-22 SUPA Berpacking 2 Pcs	S.Price
#0 - 9555 48351 2980	RM 4.00/Kad

26



喉夹 (Qty: 12 Kad x 22 Bks)

Klip Kepala Paip #13-20 SUPA Berpacking 2 Pcs	S.Price
#00 - 9555 48351 2973	RM 3.80/Kad

27



喉夹 (Qty: 12 Kad x 22 Bks)

Klip Kepala Paip #40-55 SUPA Berpacking 2 Pcs	S.Price
#2 - 9555 48351 9811	RM 4.80/Kad

28



30



圆门锁 (24 Set x 1 Ctn)

Kunci Pintu S/S NIKO	S. Price
#2077SS	28.00

31



铜芯脚车锁 (Qty: 1 Ctn X 60pcs)

Kunci Basikal Tembaga 4588	S. Price
32" x 15mm	13.20/Pcs
9555 48351 4588	

24



30



排庄锁 20 x 25 x 30 (Qty: 30 Doz x 1 Ctn)

Kunci Papan SUPA	S. Price
20 x 25 x 30	44.00/Ppn
9555 48350 0109	

3



排庄锁 25 x 30 x 40 (Qty: 20 Doz x 1 Ctn)

Kunci Papan SUPA	S. Price
25 x 30 x 40	58.00/Ppn
9555 48350 0116	

4



排庄锁 30 x 40 x 50 (Qty: 15 Doz x 1 Ctn)

Kunci Papan SUPA	S. Price
30 x 40 x 50	81.00/Ppn
9555 48350 0123	

6



排庄锁 40 x 50 x 60 (Qty: 10 Doz x 1 Ctn)

Kunci Papan SUPA	S. Price
40 x 50 x 60	98.00/Ppn
9555 48350 0130	

8



30

速霸牌铁体全芯卡压锁



Mangga SUPA	S. Price
No.3320 - 20mm (12 Pcs x 12 Ktk)	3.60/Pcs
9555 48350 0246	
No.3325 - 25mm (12 Pcs x 12 Ktk)	4.80/Pcs
9555 48350 0253	
No.3330 - 30mm (12 Pcs x 12 Ktk)	5.75/Pcs
9555 48350 0260	
No.3340 - 40mm (12 Pcs x 12 Ktk)	6.80/Pcs
9555 48350 0277	
No.3350 - 50mm (12 Pcs x 6 Ktk)	8.25/Pcs
9555 48350 0284	
No.3360 - 60mm (12 Pcs x 6 Ktk)	10.80/Pcs
9555 48351 4274	

2
3
4
5
6
7



速霸榔头锁 (Qty/Ctn: 12 Pcs x 10 Ktk)

Mangga SUPA Bentuk Bulat	S. Price
HP7840 - 40mm	11.60/Pcs
9555 48351 3666	
HP7850 - 50mm	15.60/Pcs
9555 48351 3659	
HP7860 - 60mm	19.60/Pcs
9555 48351 3642	

11
12
13



30



内六角螺 \boxtimes 批 (Qty: 12 Set x 10 Ktk)

Hallen Key Berpacking	S. Price
8 Pcs - 9555 48350 2820	3.60/Set

18



内六角螺 \boxtimes 批 (Qty: 12 Set x 10 Ktk)

Hallen Key Berpacking	S. Price
10 Pcs - 9555 48350 2837	4.00/Set

19



30

椰机头(Qty: 40 Pcs x 1 Ktk)



Mata Mesin Kelapa (900g)	S. Price
9555 76190 2120	32.00/Pcs

1



黑色草刀片 (Qty: 50 Pcs x 1 Ctn)

Mata Pisau Rumput Hitam S/Steel	S. Price
70x12" (9555 48351 9224)	10.50/Pcs
90x12" (9555 48351 9231)	11.50/Pcs
90x16" (9555 48351 8913)	18.50/Pcs

11

12

19



白钢割草刀片(Qty: 50 Pcs x 1 Ctn)

Mata Pisau Rumput Original SK-5 Cap Kelapa Sawit	S. Price
90x12" (9555 48351 8920)	18.00/Pcs

20



30



摩椰机（高）

Mesin Parut Kelapa SUPA	S. Price
Tinggi - 9555 48351 8326	RM 280.00/Set

23



摩椰机（矮）

Mesin Parut Kelapa SUPA	S. Price
Rendah - 9555 48351 8319	RM 290.00/Set

22



SIN TAI SOON SDN. BHD. (116948-X)

新大順貿易有限公司

30

30

~



12" 铁锯片(Qty: 10 Pcs x 10 Ikat x 10 Ktk)

Mata Gergaji Besi SUPA 12"- 24T	S. Price
9555 48351 2959	2.00/Pcs

8

12" 铁锯片(Qty: 10 Pcs x 10 Ikat x 10 Ktk)

Mata Gergaji Besi SUPA 12"-18T	S. Price
9555 48351 2942	2.00/Pcs

16



SIN TAI SOON SDN. BHD. (116948-X)

新大順貿易有限公司

31

30



洗衣机A 进水头 (12 Pcs x 6 Bks)

Mesin Basuh A Joint	S. Price
~	5.00/Pcs

1



洗衣机A-B 进水头 (12 Pcs x 6 Bks)

Mesin Basuh A-B Joint	S. Price
~	8.00/Pcs

2



30

洗衣机出水喉 (Qty: 50 Pcs)



Paip KELUAR Air Mesin Basuh Baju Kelabu	S. Price
1.5 Meter - 9555 48350 3742	RM 7.80/Pcs
2.0 Meter - 9555 48350 3759	RM 9.50/Pcs
2.5 Meter - 9555 48350 3766	RM 11.20/Pcs
3.0 Meter - 9555 48350 3773	RM 12.40/Pcs

3
4
5
6

洗衣机进水喉 (Qty: 24 Pcs)



Paip MASUK Air Mesin Basuh Baju	S. Price
2.0 Meter	RM 16.80/Pcs
9555 48350 3803	
2.5 Meter	RM 18.80/Pcs
9555 48350 3810	
3.0 Meter	RM 20.80/Pcs
9555 48350 3827	

11
8
9

洗衣机出水喉 (Qty: 40 Pcs)



Paip KELUAR Air Mesin Basuh Baju	S. Price
1.5 Meter 3215	RM 11.60/Pcs
9555 48351 3215	
2.0 Meter 3222	RM 13.80/Pcs
9555 48351 3222	
2.5 Meter 3239	RM 16.00/Pcs
9555 48351 3239	
3.0 Meter 3246	RM 18.00/Pcs
9555 48351 3246	

13
14
15
16



30



接喉 (Qty/Ctn: 20 Ktk x 50 Pcs)

Paip Sambung Tanpa Packing	S. Price
~	20.00/Ktk

1



卡庄接喉(Qty/Ctn: 264 Kad x 1 Ctn)

Paip Sambung Berpacking	S. Price
9555 48350 3179	1.80/Kad

75



T形接喉 (Qty/Ctn: 1 Ctn x 500 Pcs)

Paip Sambung Bentuk T Tanpa packing	S. Price
Tanpa Packing	3.00/Pcs

2

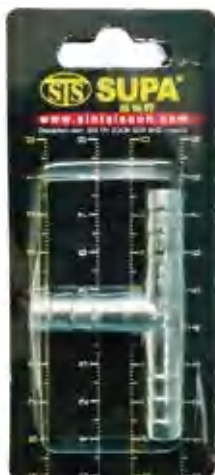

T形接喉 (包装) (Qty: 264 Kad x 1 Ctn)

Paip Sambung Bentuk T SIAP Packing	S. Price
9555 48351 4755	3.70/Kad

72



30



3号羊眼圈 (包装) Qty:264 Kad x 1 Ctn

No.3 Skru Langsir (Packing)	S. Price
~	1.80/kad

19



16mm 杯勾 (包装) Qty:264 Kad x 1 Ctn

16mm Lamp Hook (Packing)	S. Price
~	1.80/Kad

22



4号羊眼圈 (包装) Qty:264 Kad x 1 Ctn

Skru Langsir No. 4 (Packing)	S. Price
~	1.80/Kad

40



螺丝 Qty:264 Kad x 1 Ctn

Tapping Screw	S. Price
#08 x 1 Nih 15 Pcs	1.80/Kad

42



SIN TAI SOON SDN. BHD. (116948-X)

新大順貿易有限公司

35

30



20mm 黑皮钢牙罗絲(包装) (Qty: 120 Kad x 1 Ctn)

20mm Skru Hitam (Packing)	S. Price
9555 48350 3070	1.80/Kad

23



电线勾 (卡装) (Qty: 264 Kad x 1 Ctn)

Cable Clip Berpacking	S. Price
6mm (9555 48350 3087)	1.80/Kad
8mm (9555 48350 3094)	1.80/Kad
10mm (9555 48351 9033)	1.80/Kad

24

25

66



白钢钉(包装) (Qty: 264 Kad x 1 Ctn)

Paku Concrete S/Still (Packing)	S. Price
20mm - 9555 48350 3100	2.40/Kad
25mm - 9555 48350 3117	2.40/Kad
30mm - 9555 48351 9255	2.40/Kad
40mm - 9555 48350 3124	2.40/Kad
50mm - 9555 48350 3131	2.40/Kad

30

31

65

32

33



30

303536



303537



膨胀管加钉

Wall Plug PVC Siap Paku Berpacking	S. Price
No.6 (Qty: 12 Kad x 10 Ktk) 9555 48350 2943	1.95/Kad
No.8 (Qty: 12 Kad x 10 Ktk) 9555 48350 2950	1.95/Kad

36

37



接线柱 (Qty: 10 Pcs x 6 Pek)

Connector Wire Bertembaga Tanpa Packing	S. Price
No.5A - 9555 48351 4793	1.80/Pcs
No.10A - 9555 48351 4809	2.00/Pcs
No.15A - 9555 48351 8418	2.40/Pcs

47

48

73



SIN TAI SOON SDN. BHD. (116948-X)

新大順貿易有限公司

35

30



铁膨胀螺丝 (Qty: 10 Kad x 15 Bks)

Wallplug Besi Besar Berpacking 10mm X 60mm 3 Pcs	S. Price
9555 48351 9743	3.30/Kad

53



铁膨胀螺丝 (Qty: 10 Kad x 15 Bks)

Wallplug Besi Kecil Berpacking 8mm X 50mm 6 Pcs	S. Price
9555 48351 9750	3.30/Kad

54



30



No.8 灯勾(Qty: 12 Kad x 15 Bks)

Cangkuk No.8 Berpacking 5 Pcs 9453	S. Price
9555 48351 9453	3.20/Kad

55



No.10 灯勾(Qty: 12 Kad x 15 Bks)

Cangkuk No.10 Berpacking 4 Pcs 9460	S. Price
9555 48351 9460	3.20/Kad

56



No.12 灯勾(Qty: 12 Kad x 15 Bks)

Cangkuk No.12 Berpacking 3 Pcs 9477	S. Price
9555 48351 9477	3.20/Kad

57



No.14 灯勾(Qty: 12 Kad x 15 Bks)

Cangkuk No.14 Berpacking 2 Pcs 9484	S. Price
9555 48351 9484	3.20/Kad

58



30



短柄手拉脚车泵 (Qty/Ctn: 50 Pcs x 1 Ctn)

Pam Basikal Pendek SUPA 9408	S. Price
9555 48351 9408	16.40/Pcs

28



轻型手拉脚车泵 (Qty/Ctn: 25 Pcs x 1 Ctn)

Pam Basikal SUPA 4236	S. Price
9555 48351 4236	19.60/Pcs

22



多功能手拉脚车泵 (Qty/Ctn: 25 Pcs x 1 Ctn)

Pam Basikal SUPA Serbaguna 4595	S. Price
9555 48351 4595	41.00/Pcs

24



30



塑膠油抽 (Qty: 1 Doz x 12 Papan)

Pam Minyak Plastik Picit SUPA 3186	S. Price
9555 48350 3421	RM 69.60/Doz

7



塑膠油抽 (Qty: 30 Pcs x 1 Ctn)

Pam Minyak Plastik SUPA 44 Galon 3918	S. Price
9555 48351 9187	RM 24.00/Pcs

17



塑膠油抽 (Qty: 48 Pcs x 1 Ctn)

Pam Minyak Plastik Tarik SUPA (8517)	S. Price
9555 48351 8517	RM 6.70/Pcs

30



铁油抽 (Qty: 36 Pcs x 1 Ctn)

Pam Minyak Besi	S. Price
货物没有包退 Barang Tak Boleh Return	RM 18.70/Pcs

15



高级胶柄厕所泵 (Qty: 12 Pcs x 15 Bks)

Pam Tandas Tangkai Plastik	S. Price
~	RM 7.00/Pcs

9



30



药水泵(Qty: 10 Pcs x 1 Ctn)

Pam Racun Cap DOFRA	S. Price
16 Liter	184.00/Pc
20 Liter	196.00/Pc

10
16



30



棕油树巴冷刀 (Qty: 6 Pcs x 4 Ikat)

Parang Cap Kelapa Sawit	S. Price
115 - 38cm	33.30/Pcs
9555 48350 2349	
117 - 38.5cm	35.80/Pcs
9555 48350 2356	
120 - 48cm	38.30/Pcs
9555 48350 2363	

1
2
3



棕油树巴冷刀 (Qty: 6 Pcs x 4 Ikat)

Parang Sarung Cap Kelapa Sawit	S. Price
No. 105	34.00/Pcs
9555 48350 2318	
No. 125	36.00/Pcs
9555 48350 2325	
No. 135	38.00/Pcs
9555 48350 2332	

14
15
16



皮合刀 (Qty: 6 Pcs x 4 Ikat)

Parang Sarung Cap Kelapa Sawit No. 85	S. Price
No. 85 (9555 48351 9200)	23.00/Pcs

45



30

亚答刀 (Qty: 10 Pcs x 3 Ikat)



Parang Atap	S. Price
10" - 9555 48350 2370	20.00/Pcs
12" - 9555 48350 2387	21.00/Pcs
14" - 9555 48350 2394	22.00/Pcs
16" - 9555 48350 2400	23.00/Pcs
18" - 9555 48350 2417	24.00/Pcs

21
22
23
24
37

钢亚答刀 (Qty: 10 Pcs x 3 Ikat)



Parang Atap S/Steel Cap Kelapa Sawit	S. Price
12" - 9555 48351 2904	27.50/Pcs
14" - 9555 48351 2898	29.50/Pcs

48
49

棕油树黑身巴冷刀 (Qty: 60 Pcs x 1 Ctn)



Parang Hitam Cap Kelapa Sawit	S. Price
No. 851 - 12.5"	32.00/Pcs
9555 48351 4199	
No. 850 - 16.5"	38.00/Pcs
9555 48351 4205	

41
42



SIN TAI SOON SDN. BHD. (116948-X)

新大順貿易有限公司

37

30

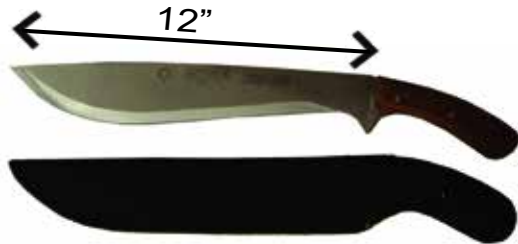

棕油树巴冷刀 (Qty: 50 Pcs x 1 Ctn)

Parang Cap Kelapa Sawit	S. Price
808-3 12" Sedang (9555 48351 4175)	RM 29.60/Pcs

28



一号材刀 (Qty: 60 Pcs x 1 Ctn)

Parang Kayu Besar No.1	S. Price
9555 48350 0703	RM 18.00/Pcs

44



30



10.5"

单支铁柄种花铲 (Qty: 200 Pcs x 1 Ctn)

Penyodok Single Tangkai Besi	S. Price
9555 48351 3925	RM 3.80/Pcs

1

单支白钢种花铲 (Qty: 48 Pcs x 1 Ctn)

Penyodok Single Stainless Steel	S. Price
9555 48351 8210	RM 8.50/Pcs

1-SS

三支庄铁柄种花铲 (Qty: 60 Set x 1 Ctn)

Penyodok Tangkai Besi 3 Pcs/Set	S. Price
9555 48351 4991	RM 12.80/Set

3



SIN TAI SOON SDN. BHD. (116948-X)

新大順貿易有限公司

42

30



漆盘 (Qty: 2 Ctn x 50 Pcs)

Pinggan Cat	S. Price
9555 48351 3345	RM 2.60/Pcs

1



30



铜水枪头 (Qty: 30 Pcs X 2 Ktk)

Pistol Paip Tembaga XLH-110	S. Price
9555 48350 3520	11.50/Pcs

3



重型水枪 (升级版) (Qty: 6 Pcs X 10 Bks)

Pistol Paip 4762 (Naik Taraf)	S. Price
9555 48351 4762	17.00/Pcs

1



水枪 (升级版) (Qty: 6 Pcs X 10 Bks)

Pistol Paip 4779 (Naik Taraf)	S. Price
9555 48351 4779	11.60/Pcs

2



30



钳子 12Pcs x 10Ktk

Plier SUPA	S. Price
6" - 9555 48351 8760	11.00/pcs
8" - 9555 48351 8777	12.00/pcs

8
9

斜嘴钳 12Pcs x 10Ktk

Cutter SUPA	S. Price
6" - 9555 48351 8784	10.00/pcs

10



尖嘴钳 12Pcs x 10Ktk

Plier Tajam SUPA	S. Price
6" - 9555 48351 8791	10.00/pcs

11



30

狗铁链



Rantai Haiwan	S. Price	
No.16 - 9555 48351 3253	49.00/Doz	4
1 Doz x 10 Ktk		
No.20 - 9555 48351 3529	57.00/Doz	5
1 Doz x 10 Ktk		
No.25 - 9555 48351 3543	63.00/Doz	7
1 Doz x 10 Ktk		
No.30 - 9555 48351 3260	78.00/Doz	8
1 Doz x 10 Ktk		
No.35 - 9555 48351 3277	88.00/Doz	9
1 Doz x 10 Ktk		
No.40 - 9555 48351 3284	108.00/Doz	10
1 Doz x 5 Ktk		
No.45 - 9555 48351 3291	137.00/Doz	11
1 Doz x 5 Ktk		
No.50 - 9555 48351 4434	165.00/Doz	35
1 Doz x 5 Ktk		



多用宠物铁链 (Qty: 6 Pcs x 12 Bks)

Rantai Haiwan Multi-Pakai	S. Price	
No.50 - Tebal	165.00/Doz	37
9555 48351 2591		
No.45 - Nipis	137.00/Doz	38
9555 48351 2607		



SIN TAI SOON SDN. BHD. (116948-X)

新大順貿易有限公司

45

30



塑料链条 (Qty: 8 Pcs x 1 Ktk)

Rantai Plastik 6mm x 20 Meter	S. Price
Kuning (9555 75261 5329)	70.00/Pcs
Merah (9555 75261 5022)	70.00/Pcs

45-K

45-M





30

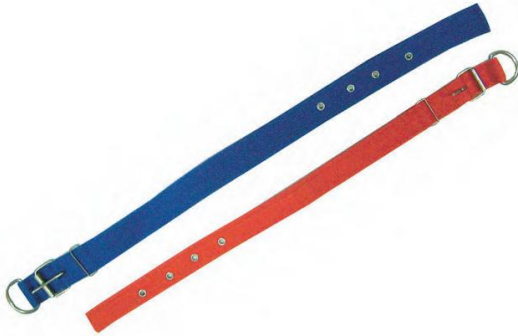

帆布狗颈圈 (Qty: 10 Pcs x 6 Bks)

Rantai Kain Leher Haiwan	S. Price
21" Besar 大	6.80/Pcs
19" Kecil 小	6.40/Pcs

27

28



帆布绿狗颈圈 (Qty: 10 Pcs x 6 Bks)

Kolar Haiwan POLICE	S. Price
~	6.60/Pcs

36



双用绿色狗颈圈 (Qty: 10 Pcs x 6 Bks)

Rantai Haiwan Leher Hijau	S. Price
	5.80/Pcs

23



30



七寸黑线条漆轮套 (Qty: 5 Set x 20 Bks)

Roda Cat Baik Set Bergaris Hitam	S. Price
7"	RM 8.60/Set

1



七寸黄线条漆轮套 (Qty: 5 Set x 20 Bks)

Roda Cat Baik Set Bergaris Kuning	S. Price
7"	RM 8.60/Set

1-P



七寸便宜漆轮套 (Qty: 100 Set x 2 Ctn)

Roda Cat Murah Set	S. Price
7" - 9555 48351 9194	RM 3.20/Set

2



七寸青色粗毛漆轮套 (Qty: 100 Set x 1 Ctn)

Roda Cat 1866 Hijau Set Baik	S. Price
7" - 9555 75260 7874	RM 10.40/Set

10

7"



七寸黑线条漆轮芯 (Qty: 5 Pcs x 20 Bks)

Span Roda Cat Kuning Bergaris Hitam	S. Price
7"-9555 75261 8115	RM 3.90/Pcs

3

7"



七寸黄线条漆轮芯 (Qty: 5 Pcs x 20 Bks)

Span Roda Cat Putih Bergaris Kuning	S. Price
7"-9555 75261 8122	RM 3.90/Pcs

3-P



30



漆轮柄 (Qty: 200 Pcs x 1 Ctn)

Tangkai Roda Cat	S. Price
18"	2.30/Pcs
24"	2.70/Pcs

4
5



漆轮柄 (Qty: 50 Pcs x 2 Ctn)

Tangkai Roda Cat 7"	S. Price
#2626	4.50/Pcs
9555 75261 5251	

21



30

台湾木柄镰刀 (Qty: 80 Pcs x 1 Ctn)

Sabit Tangkai Kayu Taiwan 2799	S. Price
9555 48351 2799	10.50/Pcs

6

本地木柄镰刀 (Qty: 10 Pcs x 5 Ikat)

Sabit Tangkai Kayu Kelapa Sawit	S. Price
9555 48351 4076	13.00/Pcs

12

木柄镰刀 (橘色) (Qty:10 Pcs X 5 Ikat)

Sabit Tangkai Kayu OREN 9910	S. Price
9555 48351 9910	13.60/Pcs

14

木柄镰刀 (长) (Qty:10 Pcs X 5 Ikat)

Sabit Mata Panjang 9927	S. Price
9555 48351 9927	13.60/Pcs

15

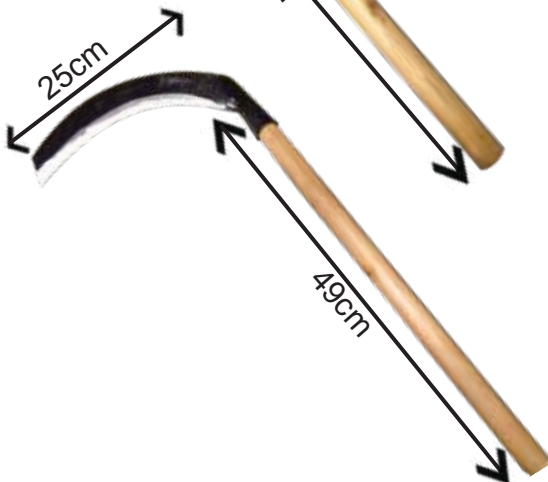
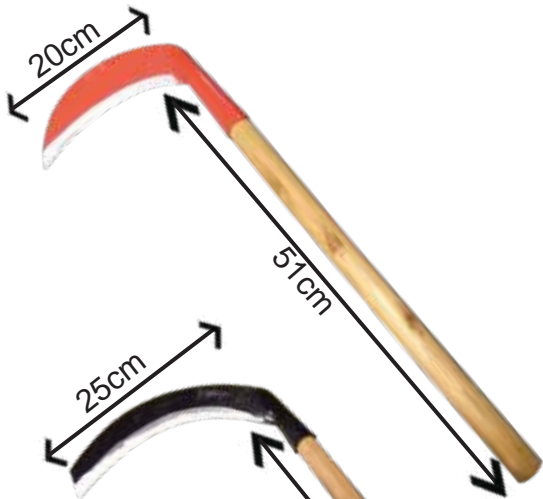



30



本地镰刀 (Qty: 10 Pcs x 5 Ikat)

Sabit Local	S. Price
9555 48351 4144	11.60/Pcs

1



红柄日本镰刀 (Qty: 120 Pcs x 1 Ctn)

Sabit Jepun Tangkai Besi Merah	S. Price
9555 48351 4151	7.20/Pcs

3



本地铁柄镰刀 (Qty: 10 Pcs x 5 Ikat)

Sabit Tangkai Besi Local Kelapa Sawit	S. Price
9555 48350 0079	15.00/Pcs

11

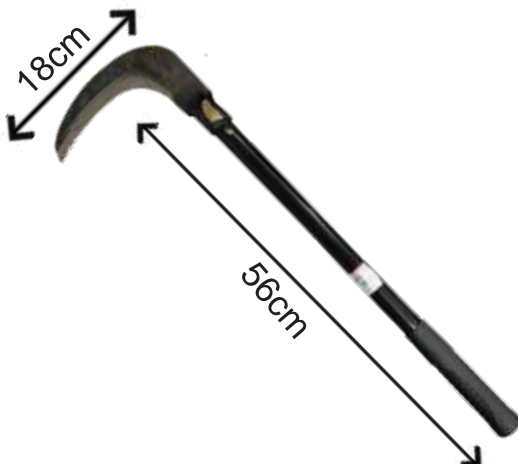

铁杆镰刀 (Qty: 60 Pcs X 1 Ctn)

Sabit Tangkai Besi 8807	S. Price
9555 48351 8807	13.60/Pcs

16



30



稻镰刀 (Qty: 200 Pcs x 1 Ctn)

Sabit Padi	S. Price
9555 48351 9316	4.20/Pcs

7



手柄镰刀 (Qty: 10 Pcs x 1 Ctn)

Sabit Mata Lebar	S. Price
~	13.80/Pcs

8

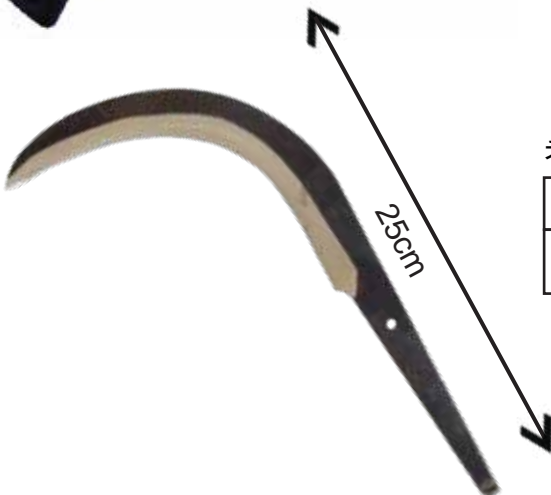

香蕉刀 (Qty: 10 Pcs x 1 Ctn)

Sabit Pisang	S. Price
~	12.00/Pcs

9



30

塑柄油灰刀 (Qty: 1 Doz x 20 Ktk)



Scrapper Tangkai Plastik	S. Price
2"	RM 30.00/Doz
9555 48351 4830	
3"	RM 38.40/Doz
9555 48351 4410	
4"	RM 43.20/Doz
9555 48351 3352	

8

9

10



(Qty: 1 Ktk x 24 Pcs)

Scrapper Tingkap	S. Price
9555 48351 2393	RM 5.00/Pcs

15

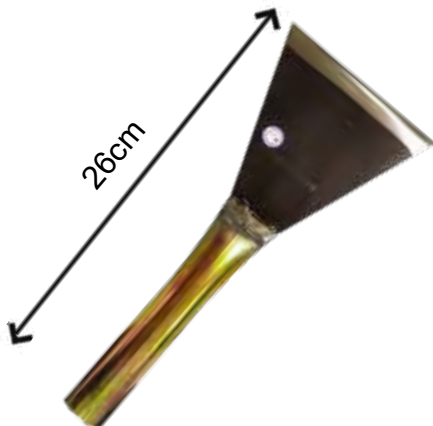

重型油灰刀 (Qty: 6 Pcs x 10Ktk)

Scrapper 5" Heavy Duty Tangkai Besi	S. Price
9555 48351 8258	RM 11.00/Pcs

16



30



七彩门插

Selak Pintu Mas	S. Price
100mm - 4" (1Doz x 20Ktk)	29.00/Doz
150mm - 6" (1Doz x 10Ktk)	35.00/Doz

6
7

七彩门插 (Qty: 12 Pcs x 10 ktk)

Selak Pintu Mas Siap Skru Berpacking	S. Price
100mm - 4" (9555483513017)	3.90/Pcs
150mm - 6" (9555483514441)	4.80/Pcs

31
34

七彩锁牌 (Qty: 12 Pcs x 10 ktk)

Ibu Kunci Mas Siap Skru Berpacking	S. Price
65mm - 9555 48351 9972	3.00/Pcs
85mm - 9555 48351 9989	4.20/Pcs
115mm - 9555 48351 9996	6.40/Pcs

35
36
37



30



白钢锁牌 (Qty: 12 Kad x 22 Bks)

Ibu Kunci S/Still (Packing)	S. Price
2" - 9555 48350 3247	2.20/Kad
3" - 9555 48350 3254	3.00/Kad
4" - 9555 48350 3261	4.00/Kad

22
23
24



白钢门插 (Qty: 12 Kad x 10 Bks)

Selak S/Still Berpacking	S. Price
2" - 9555 48350 2646	3.20/Kad
3" - 9555 48350 3285	4.20/Kad
4" - 9555 48350 2653	4.80/Kad

25
26
27



304928



304930

薄庄白钢合页 (Qty: 12 Kad x 20 Bks)

Engsel S/Still Nipis Berpacking	S. Price
2" - 9555 48350 2813	2.60/Kad
3" - 9555 48350 2790	3.20/Kad
4" - 9555 48350 2806	5.00/Kad
Qty: 120 Pcs x 1 Ctn	

28
29
30



30



灯勾 (Qty: 250 Ktk x 1 Ctn)

No.3 Lamp Hook Kotak 100's	S. Price
9555 48351 3901	5.00/Pcs

5



羊眼圈 (Qty: 250 Ktk x 1 Ctn)

No.3 Skru Langsir Kotak 100's	S. Price
9555 48351 3895	5.00/Pcs

6



灯勾

Cangkuk Tanpa Packing	S. Price
#8 (Qty: 16 Ktk x 144 Pcs)	34.00/Ktk
#10 (Qty: 10 Ktk x 144 Pcs)	49.50/Ktk
#12 (Qty: 8 Ktk x 144 Pcs)	70.00/Ktk
#14 (Qty: 6 Ktk x 144 Pcs)	108.00/Ktk
#16 (Qty: 4 Ktk x 144 Pcs)	122.00/Ktk

7

8

9

10

11

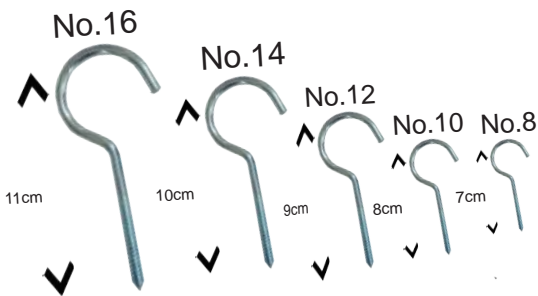



30

尖灰匙 (Qty: 1 Doz x 10 Ktk)



Sudip Simen	S. Price
150mm - 6"	44.00/Doz
9555 48351 3314	
175mm - 7"	49.20/Doz
9555 48351 3321	

2

3

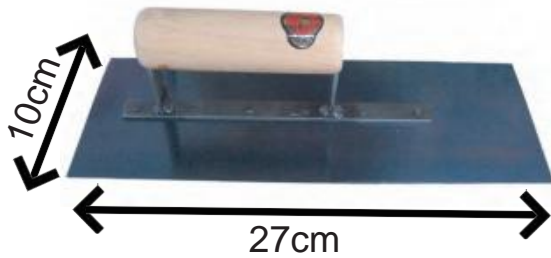

四方铁薄灰匙 (Qty: 1 Doz x 1 Ctn)

Sudip Simen Besi Nipis #7450	S. Price
4"	90.00/Doz

5



30



窗簾繩 (Qty: 20 Ktk x 1 Ctn)

Tali Langsir	S. Price
9555 48351 3864	19.00/Ktk

29

彩色拉尺



Tali Tape Colour	S. Price
(3.0 meter) Qty: 12 Pcs x 18 Ktk	3.70/Pcs
9555 48351 9040	
(5.0 meter) Qty: 12 Pcs x 18 Ktk	5.60/Pcs
9555 48351 2782	
(7.5 meter) Qty: 12 Pcs x 12 Ktk	11.00/Pcs
9555 48351 2775	

30

31

32



窗簾繩 (Qty: 7 Pcs x 20 Bks)

Tali Langsir Berpacking 2.5 Meter	S. Price
9555 48351 9903	3.90/Pcs

59



30



纯原料割草线(盒庄) (Qty: 50 Pcs x 1 Ctn)

Tali Tangsi Mesin Rumput	S. Price
9555 48350 0574 (1 LBS)	19.00/Pek

50-K



纯原料割草线(盒庄) (Qty: 50 Pcs x 1 Ctn)

Tali Tangsi Mesin Rumput	S. Price
9555 48351 2461 (1 LBS)	19.00/Pek

50-O



纯原料旋转割草线 (Qty: 50 Pcs x 1 Ctn)

Tali Tangsi Mesin Rumput Berpintal (400gm±)	S. Price
9555 48351 9965	21.00/Pcs

57



5公斤黄色原料割草线 (Qty: 4 Bks x 1 Ctn)

Tali Tangsi Mesin Rumput 5 Kg KUNING	S. Price
9555 48350 0239	200.00/Bks

58-K



纯原料割草线(2000gm±) (Qty: 8 Pcs x 1 Ctn)

Tali Tangsi Mesin Rumput 5Lbs SUPA	S. Price
9555 48351 4014 黄	96.00/Pek
9555 48351 4021 桔黄	96.00/Pek

39-K

39-O

5公斤桔红纯原料割草线橘 (Qty: 2 Pcs x 2 Ktk x 1Ctn)

Tali Tangsi Mesin Rumput 5Kg OREN	S. Price
9555 48351 9279	180.00/Bks

60-O



30



纯日本原料割草线 (Qty: 30 Pek x 1 Ctn)

Tali Tangsi Mesin Rumput Jepun 800 X 2.4mm SUPA	S. Price
9555 48350 0093 黄	RM 50.00/Pek
9555 48351 4458 桔红	RM 50.00/Pek

28-K
28-O



纯日本原料特粗割草线 (Qty: 30 Pek x 1 Ctn)

Tali Tangsi Mesin Rumput Jepun 800 X 3mm SUPA	S. Price
9555 48351 8555 黄	RM 50.00/Pek
9555 48351 8562 桔红	RM 50.00/Pek

65-K
65-O



纯日本原料割草线 (Qty: 30 Pek x 1 Ctn)

Tali Tangsi Mesin Rumput Dua Warna Jepun 800 X 2.4mm SUPA	S. Price
9555 48351 9286 双色	RM 56.00/Pek

28-DW



本地加粗割草线 (Qty: 30 Pek x 1 Ctn)

Tali Tangsi Mesin Rumput Oren Malaysia 800 X 2.7mm SUPA	S. Price
9555 48351 8661	RM 50.00/Pek

58-O



30



黄纯原料割草线 (Qty: 20 Bks x 1 Ctn)

Tali Tangsi Mesin Rumput 2.4mm SIAP POTONG KUNING (5 Pek X100Pcs ±)	S. Price
9555 48350 3155	RM50.00/Pek

51-K



12' ' 桔红纯原料割草线 (Qty: 20 Bks x 1 Ctn)

Tali Tangsi Mesin Rumput 2.4mm SIAP POTONG OREN (5 Pek X 100Pcs ±)	S. Price
9555 48350 3162	RM50.00/Pek

51-O



12' ' 桔红纯原料割草线 (Qty: 20 Bks x 1 Ctn)

Tali Tangsi Mesin Rumput 2.4mm SIAP POTONG OREN Malaysia (5 Pek X 100Pcs ±)	S. Price
9555 48351 8579	RM50.00/Pek

51-MAL



12' ' 青纯原料割草线 (Qty: 20 Bks x 1 Ctn)

Tali Tangsi Mesin Rumput 2.4mm SIAP POTONG HIJAU (5 Pek X 100Pcs ±)	S. Price
9555 48350 3148	RM50.00/Pek

51-H



12' ' 双色纯原料割草线 (Qty: 20 Bks x 1 Ctn)

Tali Tangsi Mesin Rumput 2.4mm SIAP POTONG DUA WARNA (5 Pek X 100Pcs ±)	S. Price
9555 48351 9262	RM50.00/Pek

51-DW



30

12' ' 黄纯原料割草线 (三角形)(Qty: 20 Bks x 1 Ctn)

Tali Tangsi Mesin Rumput Segi Tiga SIAP POTONG KUNING	S. Price	
9555 48351 8371	RM 50.00/Pek	68-K

12' ' 桔红纯原料割草线(三角形)(Qty: 20 Bks x 1 Ctn)

Tali Tangsi Mesin Rumput Segi Tiga SIAP POTONG OREN	S. Price	
9555 48351 8388	RM 50.00/Pek	68-O

12' ' 黄纯原料特粗割草线 (Qty: 20 Bks x 1 Ctn)

Tali Tangsi Mesin Rumput 3.0mm SIAP POTONG KUNING	S. Price	
9555 48351 8395	RM 50.00/Pek	69-K

12' ' 桔红纯原料特粗割草线 (Qty: 20 Bks x 1 Ctn)

Tali Tangsi Mesin Rumput 3.0mm SIAP POTONG OREN	S. Price	
9555 48351 8401	RM 50.00/Pek	69-O

12' ' 双色锯齿线割草线 (Qty: 20 Bks x 1 Ctn)

Tali Tangsi Mesin Rumput Bergigi SIAP POTONG	S. Price	
9555 48351 8364	RM 70.00/Pek	67



30



割草盘 (Qty: 100 Pcs x 1 Ctn)

Piring Mesin Rumput SUPA	S. Price
9555 48350 2660	RM 7.20/Pcs

55



2 IN 1割草盘 (Qty: 100 Pcs x 1 Ctn)

Piring Mesin Rumput 2 IN 1 SUPA	S. Price
9555 48351 8548	RM 8.80/Pcs

66



30



剪便索 (Qty: 20 Pcs x 5 Ikat)

Tali Warna PE Siap Potong 40 Ft	S. Price
2mm - 9555 48351 9088	2.60/Pcs

61



剪便索 (Qty: 20 Pcs x 5 Ikat)

Tali Warna PE Siap Potong 38 Ft	S. Price
3mm - 9555 48351 9095	3.00/Pcs

62



剪便青索 (Qty: 20 Pcs x 5 Ikat)

Tali Hijau PE Siap Potong 20Ft	S. Price
4mm	2.10/Pcs
5mm	3.00/Pcs
6mm	3.90/Pcs

3

4

5



剪便白索 (Qty: 20 Pcs x 5 Ikat)

Tali Putih PPD Siap Potong 20Ft	S. Price
4mm	2.40/Pcs
5mm	3.50/Pcs
6mm	4.60/Pcs

7

8

9

SIN TAI SOON SDN. BHD. (116948-X)

新大順貿易有限公司

56

30

繩



Tali PE	S. Price	
1.5mm (300g)	RM 12.00/Pcs	49
Qty: 50 Pcs x 2 Ctn		
9555 48351 4946		
2.0mm (300g)	RM 12.00/Pcs	1
Qty: 50 Pcs x 2 Ctn		
9555 48351 4953		
2.5mm (350g)	RM 14.00/Pcs	2
Qty: 50 Pcs x 2 Ctn		
9555 48351 4960		
3.0mm (430g)	RM 17.00/Pcs	45
Qty: 50 Pcs x 2 Ctn		
9555 48351 4977		



30

白胶纸



	Masking Tape	S. Price	
1"	24mm - 12 Pcs x 12 Bks x 3 Ctn	14.00/Bks	19
	9555 48351 3611		
1"半	38mm - 8 Pcs x 12 Bks x 3 Ctn	14.00/Bks	20
	9555 48351 3628		
2"	48mm - 6 Pcs x 12 Bks x 3 Ctn	14.00/Bks	21
	9555 48351 3635		



透明胶纸 (Qty: 6 Pcs x 12 Bks)

	OPP Tape	S. Price	
	90y x 48mm	4.00/Pcs	29



30

24mm布颜色胶纸

Cloth Tape 24mm	S. Price
Biru 蓝 (Qty: 144 Pcs x 1 Ctn)	1.70/Pcs
9555 48351 4618	
Hijau 青 (Qty: 144 Pcs x 1 Ctn)	1.70/Pcs
9555 48351 4625	
Hitam 黑 (Qty: 144 Pcs x 1 Ctn)	1.70/Pcs
9555 48351 4632	
Kuning 黄 (Qty: 144 Pcs x 1 Ctn)	1.70/Pcs
9555 48351 4649	
Merah 红 (Qty: 144 Pcs x 1 Ctn)	1.70/Pcs
9555 48351 4658	
Silver 银 (Qty: 144 Pcs x 1 Ctn)	1.70/Pcs
9555 48351 4663	



48mm布颜色胶纸

Cloth Tape 48mm	S. Price
Biru 蓝 (Qty: 72 Pcs x 1 Ctn)	3.50/Pcs
9555 48351 4670	
Hijau 青 (Qty: 72 Pcs x 1 Ctn)	3.50/Pcs
9555 48351 4687	
Hitam 黑 (Qty: 72 Pcs x 1 Ctn)	3.50/Pcs
9555 48351 4694	
Kuning 黄 (Qty: 72 Pcs x 1 Ctn)	3.50/Pcs
9555 48351 4700	
Merah 红 (Qty: 72 Pcs x 1 Ctn)	3.50/Pcs
9555 48351 4717	
Silver 银 (Qty: 72 Pcs x 1 Ctn)	3.50/Pcs
9555 48351 4724	





30



S电胶纸UPA电胶纸

SUPA Wire Tape			S. Price
Biru	蓝	10 Biji x 50 Roll	0.76/Pcs
Hijau	青	10 Biji x 50 Roll	0.76/Pcs
Kuning	黄	10 Biji x 50 Roll	0.76/Pcs
Merah	红	10 Biji x 50 Roll	0.76/Pcs
Putih	白	10 Biji x 50 Roll	0.76/Pcs

23

24

26

27

28



红白带 (Qty: 72 Pcs x 1 Peti)

Tape Merah Putih TANPA Lekat	S. Price
70mmX50 Meter (9555 48351 9361)	6.40/Roll

34

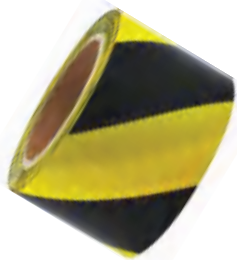

黑黄带 (Qty: 72 Pcs x 1 Peti)

Tape Hitam Kuning TANPA Lekat	S. Price
70mmX50 Meter (9555 48351 9354)	6.40/Roll

43

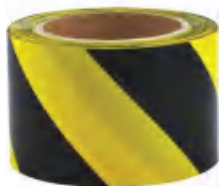

黑黄黏胶纸 (Qty: 6 Pcs x 12 Bks)

Tape Lekat Kuning Hitam	S. Price
4.8cm x 16 Meter	8.00/Roll
9555 48351 2744	

37



SIN TAI SOON SDN. BHD. (116948-X)

新大順貿易有限公司

57

30



拉伸膜 (Qty: 6 Pcs x 4 Peti)

Pallet Stretch Film 2Kg ±	S. Price
50cm - CLEAR (透明)	30.50/Pcs
50cm - HITAM (黑色)	40.00/Pcs

41

41-HT

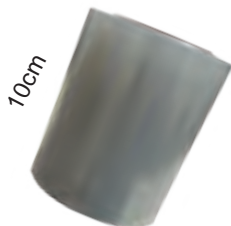

拉伸膜 (Qty: 36 Pcs x 1 Peti)

Mini Stretch Film 130m ±	S. Price
10cm	6.00/Pcs

45



30



泡沫包装

Bubble Wrap SL10	S. Price
100 Meter X 1 Roll	136.00/Pcs

44



易碎胶纸 (Qty: 6 Pcs X 12 Bks X 5 Ctn)

Opp Tape FRAGILE	S. Price
48mm X 45 Meter	3.90/Pcs
9555 48351 8869	

46



30



风扇净水器 (Qty: 300 Pcs x 1 Ktk)

Tapis Paip Berkipas Boleh Lentur	S. Price
6959 70842 0150	3.60/Pcs

5



30



天那水 (Qty: 2 Doz x 3 Ctn)

Tinner Besar (大)	S. Price
9555 48350 3193	RM 108.00/Doz

1

天那水 (Qty: 3 Doz x 3 Ctn)

Tinner Kecil (小)	S. Price
9555 48350 3209	RM 71.00/Doz

2



土油 (Qty: 10 Ctn x 2 Doz)

Minyak Tanah	S. Price
500ml ± (9555 48351 8630)	RM 84.00/Doz
600ml ± (9555 48350 3216)	RM 103.00/Doz

22

3



火酒 (Qty: 5 Doz x 1 Ctn)

Spirit	S. Price
Besar (大) - 9555 48351 3758	RM 86.00/Doz
Kecil (小) - 9555 48351 3741	RM 55.00/Doz

4

5



30



万保路牛仔帽 (Qty: 100 Pcs x 4 Bks)

Topi Cowboy Malboro 9163	S. Price
9555 48351 9163	RM 5.70/Pcs

6



带绳大男装帽 (Qty: 140 Pcs x 3 Bks)

Topi Cowboy Bertali 8845	S. Price
9555 48351 8845	RM 8.90/Pcs

8



军绿男装帽 (Qty: 120 Pcs x 2 Bks)

Topi Cowboy Kain Askar 7480	S. Price
9555 48351 7480	RM 7.00/Pcs

9



硬皮米彩牛仔帽

(Qty: 105 Pcs X 4 Bks X 1 Ctn)

Topi Cowboy 8852	S. Price
9555 48351 8852	RM 8.80/Pcs

24



鸭嘴帽 (Qty: 25 Pcs x 4 Bks)

Topi Itik 95	S. Price
9555 48351 3420	RM 9.00/Pcs

16



30



渔夫布帽厚 (Qty: 50 Pcs x 4 Bks)

Topi Kain Nelayan Tebal 7497 厚	S. Price
9555 58351 7497	RM 5.00/Pcs

18



渔夫布帽 (军) (Qty: 50 Pcs x 4 Bks)

Topi Kain Nelayan Askar 7503	S. Price
9555 48351 7503	RM 5.20/Pcs

19



纽扣遮脸军绿帽 (厚)

(Qty: 12 Pcs x 10 Bks)

Topi Cowboy Askar Tutup MukaTebal	S. Price
~	RM 17.20/Pcs

23



贼帽 (Qty: 30 Doz x 1 Ctn)

Topi Pencuri CH	S. Price
9555 48351 2874	RM 49.80/Doz

4



泰国双色贼帽 (Qty: 20 Doz x 1 Ctn)

Topi Pencuri Thailand	S. Price
	RM 80.00/Doz

4-T

SIN TAI SOON SDN. BHD. (116948-X)
新大順貿易有限公司
60
30

帽子 (Qty: 180 Pcs x 1 Ctn)

Topi	S. Price
18"	
20" - 9555 48351 3048	9.60/Pcs

**1
2**

塑料帽 (Qty: 60 Pcs x 1 Ctn)

Topi Plastik Warna 18"	S. Price
~	14.60/Pcs

22



30



零形塞子 (Qty: 10 Papan x 1 Ctn)

Wasih O-Ring 6 Pcs x 30 Bks	S. Price
9555 48351 9293	46.00/Ppn

2



小龙头塞子 (Qty: 20 Papan x 1 Ctn)

Wasih Kecil 3 Pcs x 24 Bks	S. Price
~	7.00/Ppn

3



大龙头塞子 (Qty: 20 Papan x 1 Ctn)

Wasih Kecil 2 Pcs x 24 Bks	S. Price
~	7.00/Ppn

4



大龙头塞子 (Qty: 10 Papan x 1 Ctn)

Wasih Shower 3 Pcs x 40 Bks	S. Price
9555 48351 9309	24.00/Ppn

6





SIN TAI SOON SDN. BHD. (116948-X)

新大順貿易有限公司

61

30



陀螺塞子 (Qty: 200 Pcs x 10 Ktk)

Wasih Gasing Tanpa Packing	S. Price
~	0.60/Pcs

1



陀螺塞子 (Qty: 12 Card X 22 Bks)

Wasih Gasing Berpacking 4's	S. Price
9555 48351 9880	3.00/Pcs

5



SIN TAI SOON SDN. BHD. (116948-X)

新大順貿易有限公司

63

30



钉袋 (Qty: 12 Doz x 1 Ctn)

Beg Paku Bertali Klip	S. Price
~	64.00/Doz

1



钉袋 (Qty: 12 Doz x 1 Ctn)

Beg Paku Bertali Kain	S. Price
~	44.00/Doz

2



30



水龙头胶布 (Qty: 100 Pcs x 10 Ktk)

Selotaip Paip	S. Price
~	0.58/Pc

12



木工笔 (Qty: 6 Doz x 16 Ktk)

Pensil Tukang	S. Price
~	11.00/Doz

17



麻袋针 (Qty: 100pcs x 10ktk)

Jarum Guni	S. Price
~	0.60/Pcs

6



锄头尖 (Qty: 100 Pcs x 1 Ctn)

Baji	S. Price
~	0.90/Pcs

2



锄头尖 (Qty: 12 Card x 22 Bks)

Baji 3 Pcs SIAP Packing	S. Price
9555 48351 2706	3.20/Pcs

37



30

颜色巴冷刀柄 (Qty: 300 Pcs x 1 Ctn)

Ulu Parang Color	S. Price
~	1.50/Pcs

16



鸟头巴冷刀柄

Ulu Parang Burung Kepala Besi	S. Price
~	2.50/Pcs

20



虎头巴冷刀柄 (Qty: 250 Pcs x 1 Ctn)

Ulu Parang Harimau Kepala Besi	S. Price
~	3.20/Pcs

34



黑色巴冷刀柄 (Qty: 300 Pcs x 1 Ctn)

Ulu Parang Hitam Kepala Besi	S. Price
~	2.40/Pcs

23



开椰钳 (Qty: 4 Ikat x 5 Pcs)

Buka Kelapa	S. Price
9555 48350 0055	40.00/Pcs

3



干糕铲 (Qty: 10 Pcs x 4 Ctn)

Kacau Dodol	S. Price
9555 48350 3377	8.00/Pcs

7





30



透明做工眼镜 (Qty: 12 Pcs x 40 Ktk)

Cermin Mata Kerja Warna Clear	S. Price
9555 48351 8937	2.40/Pcs

4



游泳眼镜 (Qty: 2 Doz x 3 Ctn)

Cermin Mata Swin Mask YD-18	S. Price
~	204.00/Doz

25



朴墙膏(Qty:36 Pcs x 1 Ctn)

Putty Filler 0.5Kg	S. Price
9555 20260 3456	6.00/Pcs

11



30

九比架



L Bracket	S. Price	
6 X 8 (0.8) (Qty:24Pcs x 6Ktk)	1.80/Pcs	38
9555 48351 9606		
8 X 10 (0.9) (Qty:24Pcs x 6Ktk)	2.30/Pcs	39
9555 48351 9590		
10 X 12 (1.0) (Qty:24Pcs x 6Ktk)	3.40/Pcs	40
9555 48351 9583		
12 X 14 (1.0) (Qty:24Pcs x 5Ktk)	4.20/Pcs	41
9555 48351 9576		

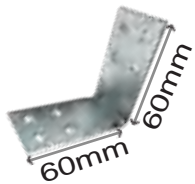

角码 (Qty : 10 Card x 5 Bks)

L Bracket Berpacking 60mm X 60mm	S. Price	
9555 48351 8999	4.60/Card	43

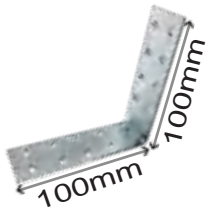

角码 (Qty : 10 Card x 5 Bks)

L Bracket Berpacking 100mm X 100mm	S. Price	
9555 48351 9002	6.80/Card	44

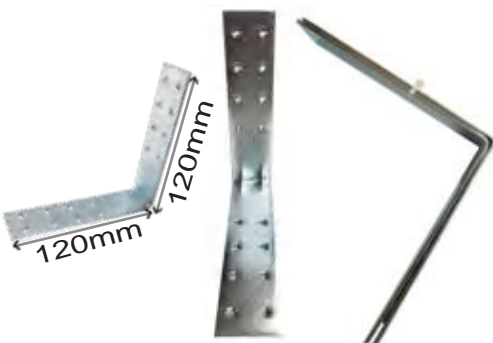

角码 (Qty : 10 Pasang x 5 Bks)

L Bracket TANPA Packing 120mm X 120mm	S. Price	
9555 48351 9019	6.80/Psg	45



40



四尺木柄 (20 Pcs x 12 Ikat)

Batang Kayu 4ft	S. Price
47"	RM 3.00/Pcs

7



颜色笨斗柄 (Qty: 10 Ikat X 50 Pcs)

Batang Kayu Skop Sampah Berbalut Tanpa Skru 27"	S. Price
	RM 1.40/Pcs

10



光身螺牙柄带勾 (MOQ: 50 Pcs x 20 Ikat)

Batang Kayu Skru Putih SIAP Cangkuk 47"	S. Price
	RM 2.00/Pcs

28



颜色螺丝木柄 (MOQ: 50 Pcs x 20 Ikat)

Batang Kayu Skru Color Berbalut 47"	S. Price
	RM 2.00/Pcs

18



颜色螺丝笨斗柄 (MOQ: 50 Pcs x 10 Ikat)

Btg Kayu Skru Skop Sampah Berbalut (Bercangkuk) 31"	S. Price
	RM 1.45/Pcs

19



颜色螺丝笨斗柄 (MOQ: 50 Pcs x 10 Ikat)

Btg Kayu Skru Skop Sampah Berbalut (Tanpa Cangkuk) 28"	S. Price
	RM 1.30/Pcs

33



40

尖木柄 (MOQ: 20 Pcs x 15 Ikat)



Batang Kayu Tajam	S. Price
6Ft	5.50/Pcs
8Ft	8.20/Pcs
10Ft	12.70/Pcs

12
14
15

6尺颜色木柄 (MOQ: 20 Pcs x 15 Ikat)



Btg Kayu Penyapu Sawang Berbalut 6 Kaki	S. Price
	6.80/Pcs

9

包胶螺丝木柄 (MOQ: 12 Pcs x 10 Ikat)



Btg Kayu Skru Colour Penyapu Sawang Berbalut 6 Kaki	S. Price
6FT	5.80/Pcs
5FT	5.10/Pcs

35
39

6尺白木柄 (MOQ: 30 Pcs x 10 Ikat)



Btg Kayu Penyapu Sawang Tanpa Balut 6 Kaki	S. Price
	5.30/Pcs

25



40



四尺杂木锄头柄 (Qty: 10 Pcs x 10 Ikat)

Batang Cangkul Murah 4Ft	S. Price
~	RM 12.50/Pcs

4



四尺半红木锄头柄 (Qty: 10 Pcs x 10 Ikat)

Batang Cangkul Baik Kayu Naga	S. Price
4.5Ft (9555 48350 4435)	RM 29.00/Pcs

5



四尺半硬木锄头柄 (Qty: 10 Pcs x 10 Ikat)

Batang Cangkul Baik Kayu Keras	S. Price
4.5Ft (9555 48350 4442)	RM 21.00/Pcs

30



加粗木柄 (Qty: 25 Pcs x 4 Ikat)

29mm Batang Kayu Getah	S. Price
4Ft	RM 6.00/Pcs
6Ft	RM 10.00/Pcs
8Ft	RM 13.00/Pcs

38

22

21



40



48" 白钢螺纹柄 (Qty: 25 Btg X 4 Ctn)

Batang Stainless Steel Bercorak	S. Price
48" - 340gm	RM 11.00/Btg
9555 48350 4350	

32



47" 铝杆 (Qty: 100 Btg X 1 Ctn)

Batang Aluminium Berjalur	S. Price
47"	RM 11.00/Btg

36



72" 喷塑铁柄 (Qty: 60 Btg X 1 Ctn)

Batang Stainless Steel	S. Price
72"-9555 48350 4381	RM 13.50/Btg

37



45" 白钢柄 (Qty: 50 Btg X 2 Ctn)

Batang Besi 45" (150gm)	S. Price
~	RM 3.50/Btg

2



40

竹鼎刷(幼) (Qty: 50 Pcs x 1 Ctn)

Berus Kual Halus	S. Price
9555 48350 4121	RM 5.80/Pcs

4

竹鼎刷(粗) (Qty: 50 Pcs x 1 Ctn)

Berus Kual Kasar	S. Price
9555 48350 4244	RM 5.80/Pcs

61

粗塑料柄钢圈竹鼎刷 (Qty: 50 Pcs x 1 Ctn)

Berus Kual Tangkai Plastik	S. Price
Kasar - 9555 48350 4404	RM 6.40/Pcs

72-K

幼塑料柄钢圈竹鼎刷 (Qty: 50 Pcs x 1 Ctn)

Berus Kual Tangkai Plastik	S. Price
Halus - 9555 48350 4398	RM 6.40/Pcs

72-H



40



排庄圆形海棉加网 (Qty: 2 Doz x 20 Papan)

Berus Jaring Bulat Berspan	S. Price
9555 48350 4275 (Papan)	29.60/Doz
9555 48350 4039 (Berus Jaring)	

47



排庄鱼网洗刷球 (Qty: 2 Doz x 30 Papan)

Berus Jaring TANPA Span	S. Price
9555 48350 4268 (Papan)	24.00/Doz
9555 48350 4022 (Berus Jaring)	

48

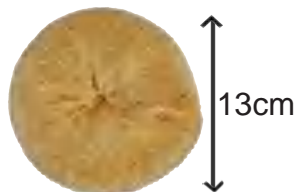

13cm



加大排庄鱼网洗刷球 (Qty: 2 Doz x 30 Papan)

Berus Jaring Besar TANPA Span	S. Price
9555 48350 4336 (Papan)	38.40/Doz
9555 48350 4329 (Berus Jaring)	

66



17cm



40



黄刷 (MOQ: 500 Pcs)

Berus Sabut Kuning	S. Price
4" (Qty: 25 Pcs x 20 Ikat)	2.20/Pcs
6" (Qty: 10 Pcs x 50 Ikat)	2.10/Pcs
8" (Qty: 10 Pcs x 50 Ikat)	3.40/Pcs

20
21
22

白刷 (Qty: 20 Pcs x 10 Bks)

Berus Sabut Putih	S.Price (RM)
4" - 9555 48350 4046	RM 2.70/Pcs
6" - 9555 48350 4053	RM 3.45/Pcs

25
26

双色刷 (Qty: 20 Pcs x 10 Bks)

Berus Sabut Dua Color Sri Lanka	S.Price (RM)
4" - 9555 48350 4084	RM 3.10/Pcs
6" - 9555 48350 4091	RM 3.90/Pcs

49
50

黄刷 (Qty: 20 Pcs x 10 Bks)

Berus Sabut Kuning Sri Lanka	S.Price (RM)
4" - 9555 48350 4176	RM 2.80/Pcs
6" - 9555 48350 4183	RM 3.10/Pcs
8" - 9555 48350 4190	RM 4.40/Pcs

58
59
60

黄刷

Berus Sabut PP	S.Price (RM)
4" - 4006 5052	RM 3.10/Pcs
(Qty: 20 Pcs x 10 Bks)	
6" - 4006 5069	RM 4.00/Pcs
(Qty: 20 Pcs x 10 Bks)	

68
69



40



蛋形塑料刷 (Qty: 160 Pcs x 1 Ctn)

Berus Plastik Bulat	S. Price
5545	3.20/Pcs

51



四方塑料刷 (Qty: 180 Pcs x 1 Ctn)

Berus Plastik Segiempat	S. Price
5553	3.20/Pcs

52



泰国四方铜刷 (Qty: 12 Pcs x 10 Ktk)

Berus Lantai Kaya Cap Buaya S44	S. Price
9555 48350 4107	3.30/Pcs

54



40

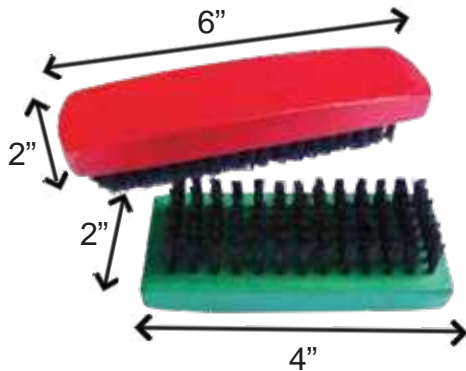

鞋刷 (Qty: 1 Doz x 20 Ktk)

Berus Kasut	S. Price
408 Besar 大	RM 21.00/Doz
9555 48350 4251	

42



熨斗青布 (Qty: 1 Doz x 12 Bks)

Berus Hijau Tangkai 505	S. Price
9555 48350 4114	RM 63.00/Doz

16



黑刷 (Qty: 20 Pcs x 30 Ikat)

Berus Hitam	S. Price
6" (B)	RM 2.75/Pcs
8"	RM 4.50/Pcs

44

18



粗刷 (Qty: 20 Pcs x 10 Bks)

Berus Sabut Kasar	S.Price (RM)
4" - 4006 5021	RM 3.90/Pcs
6" - 4006 5038	RM 5.40/Pcs
8" - 4006 5045	RM 6.40/Pcs

70

73

71

SIN TAI SOON SDN. BHD. (116948-X)

新大順貿易有限公司
02
40
中国圆铜刷 (Qty: 1 Doz x 10 Ktk)

Berus Lantai Bulat Cina	S. Price
9555 48350 4420	RM 61.20/Doz

5
加大四方全刷 (Qty: 1 Doz x 10 Ktk)

2" x 7" Berus Lantai 4-Segi Besar No.619	S. Price
9555 48350 4138	RM 73.20/Doz

45
四方钢刷 (Qty: 1 Doz x 30 Ktk)

Berus Lantai Segiempat 2" x 4 1/2"	S. Price
9555 48350 4121	RM 28.80/Doz

7

SIN TAI SOON SDN. BHD. (116948-X)

新大順貿易有限公司
80
1001
1002
特大双用方全刷 (Qty: 4 Doz x 1 ctn)

Berus Lantai 4-Segi Dua Pakai No.518 2 1/2" X 9"	S. Price
Batang Kayu Skru Putih 45" 光身螺牙柄带勾	RM 175.00/Doz
Batang Kayu Skru Color 48" 色螺丝柄	RM 175.00/Doz
Tanpa Kayu 无包柄	RM 155.00/Doz
9555 48350 8259	

400
500
600
塑料头全地刷 (Qty: 12 Pcs x 10 ctn)

Berus Lantai Tembaga Kepala Plastik F-906	S. Price
Batang Kayu Skru Putih 45" 光身螺牙柄带勾	RM 28.60/Pcs
Batang Kayu Skru Color 48" 色螺丝柄	RM 28.60/Pcs
Tanpa Kayu 无包柄	RM 25.60/Pcs
8851669997178	

400
500
600



7"



2"

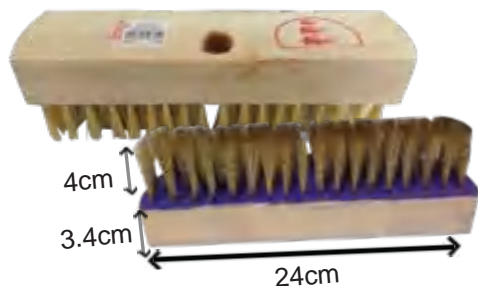

4 1/2"



4cm

3.4cm

24cm

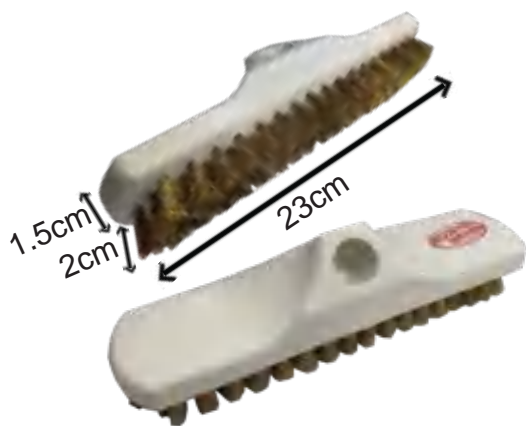

23cm

 1.5cm
2cm



40

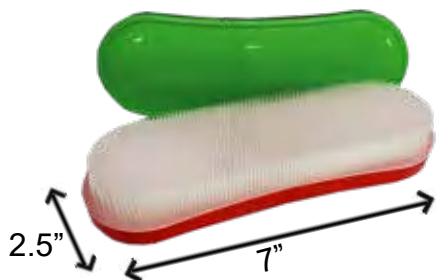

泰国原子刷 (Qty: 1 Doz x 6 Bks)

Berus Plastik No.512	S. Price
9555 48350 4428	RM 44.00/Doz

3



泰国硬丝原子刷 (Qty: 1 Doz x 10 Bks)

Berus Plastik Anchor	S. Price
8851 93880 0291	RM 56.00/Doz

35



泰国硬丝原子刷 (Qty: 1 Doz x 12 Bks)

Berus Plastik Besar 888 (No.4299)	S. Price
9555 48350 4299	RM 54.00/Doz

63

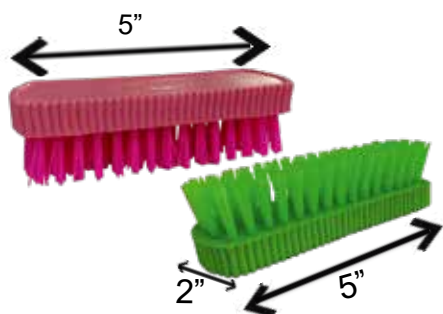

泰国硬丝原子刷 (Qty: 1 Doz x 12 Bks)

Berus Plastik Kecil 888 (No.4305)	S. Price
9555 48350 4305	RM 46.00/Doz

64



40



梅花标块六铁丝 (Qty: 12 Doz X 2 Ctn)

Steel Wool KELAWAR RM1.60	S. Price
9555 48350 4213	RM 20.40/Doz

3



狮标两块铁丝 (Qty: 12 Doz X 2 Ctn)

Steel Wool KELAWAR RM2.40	S. Price
9555 48350 4411	RM 29.60/Doz

6



50



地墊 (Qty: 120 Pcs x 2 Ctn)

Alas Kaki Baldu 40 x 60	S. Price
9555 48350 9546	RM 8.50/Pcs

33

Belakang



50

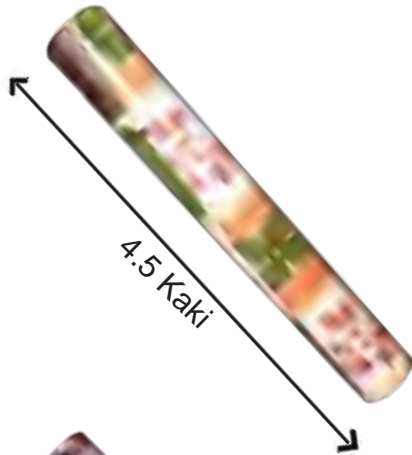

花台布 (Qty: 4 Roll x 3 Ctn)

Alas Meja Bunga	S. Price
4.5 Kaki x 27 Meter	RM 156.00/Roll

7

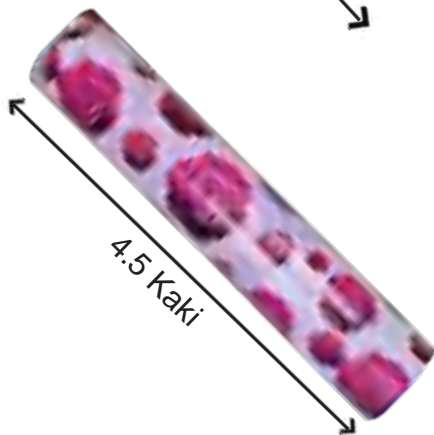

地席桌布 (Qty: 10 Roll)

Alas Meja Tikar Getah Pendek Bercorak 13 Kg	S. Price
4.5 Kaki x 25 Meter	RM 176.00/Roll

21



50

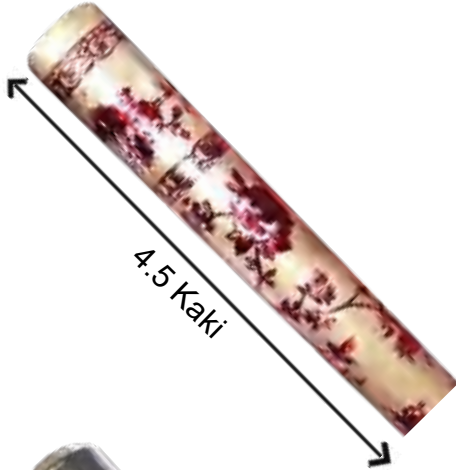

金色花台布 (Qty: 2 Roll x 6 Ctn)

Alas Meja Berkilat	S. Price
4.5 Kaki x 20 Meter	RM 197.00/Roll

49

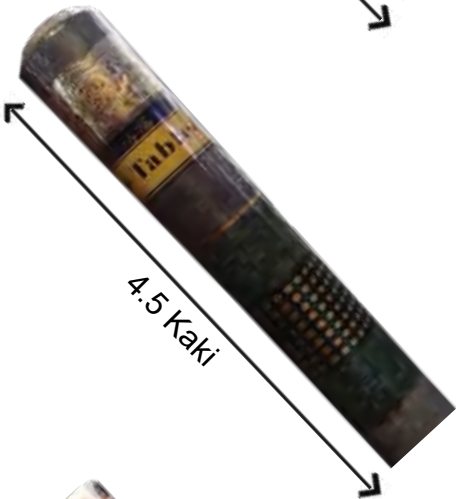

金色花台布 (Qty: 2 Roll x 6 Ctn)

Alas Meja Berkilat	S. Price
4.5 Kaki x 20 Meter	RM 230.00/Roll

49-A

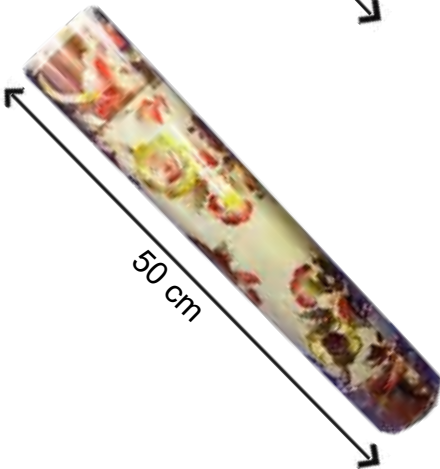

金色花小台布 (Qty: 6 Roll x 2 Ctn)

Alas Meja Berkilat	S. Price
50 cm x 20 Meter	RM 96.00/Roll

49-50



金色六人台布 (Qty: 2 Roll x 2 Ctn)

Alas Meja Berkilat (6 Kerusi) 15 Pcs	S. Price
138cm x 180cm	RM 378.00/Roll

31



50

透明台布

Alas Meja Clear	S. Price
Nipis 薄 - 0.08mm x 27 Meter x 54"	RM 89.00/Roll
4 Ctn x 6 Roll	

8-RS



4.5 Kaki

Tebal 厚 - 0.13mm x 27 Meter x 54"	RM 134.00/Roll
6 Ctn x 4 Roll	

9-RS

Tebal 厚 - 0.20mm x 50 Meter x 54"	RM 440.00/Roll
6 Roll	

47

Tebal 厚 - 0.30mm x 50 Meter x 54"	
4 Roll	RM 600.00/Roll

64



50

单色台布 (Qty: 3 Glg x 5 Ctn)



Alas Meja Warna	S. Price
4.5 Kaki x 30 Meter	156.00/Glg
Hijau Tua	
Hijau Muda	
Biru Tua	
Biru Muda	
Kuning	
Pink	
Hitam	
Oren	
Ungu	
Coklat	
Putih	
Marroon	
Merah	

10



50

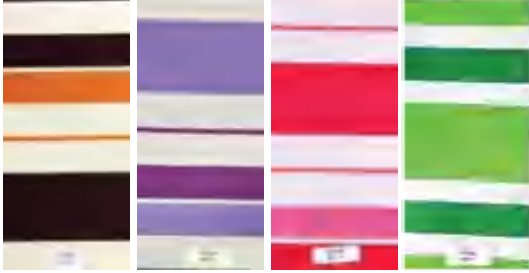

篷布 (Qty: 12 Roll)

Tarpaulin (10.5 Kg)	S. Price
4.5 Kaki x 25 Meter	RM 252.00/Roll

45



篷布 (Qty: 12 Roll)

Tarpaulin (10.5 Kg)	S. Price
4.5 Kaki x 25 Meter	RM 252.00/Roll

45-A

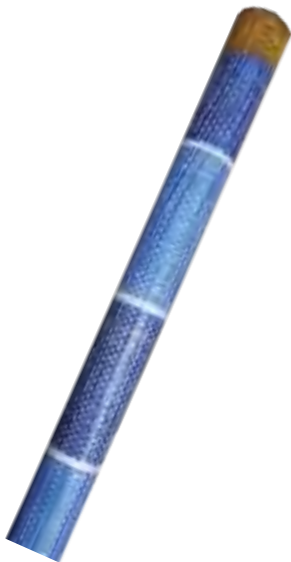

藍白帆布 (Qty: 10 Roll)

PE Tarpaulin Biru Putih (1.6 Kg)	S. Price
6 Kaki x 40 Kaki	RM 32.00/Roll

63



50



蓝色结果肥料 (Qty: 20 Pek x 5 Beg)

Baja Buah Biru No.43	S. Price
9555 48350 5012	2.80/Pek

1

400g



青色叶子肥料 (Qty: 20 Pek x 5 Beg)

Baja Daun Hijau No.45	S. Price
9555 48350 5029	2.80/Pek

2



红色开花肥料 (Qty: 20 Pek x 5 Beg)

Baja Bunga Merah No.47	S. Price
9555 48350 5036	2.80/Pek

3



黑色有机肥料 (Qty: 20 Pek x 5 Beg)

Baja Organik Tulen Hitam No.28	S. Price
9555 48350 5005	2.80/Pek

4



黄色蔬菜肥料 (Qty: 20 Pek x 5 Beg)

Baja Sayur Kuning No.39	S. Price
9555 48350 5043	2.80/Pek

6



50



醋盐 (Qty: 20 Pek x 5 Bks)

Serbuk Pembeku Getah Cop Pokok Getah 1Kg	S. Price
9555 48350 5753	5.60/Pcs

5



胶醋 (MOQ: 1 Doz x 10 Box)

C.G - H9099	S. Price
~	96.00/Doz

7



50



幼沙龙吊 (Qty: 18 Doz x 1 Ctn)

Besi Sarung Buai Epoxy Halus 14"	S. Price
~	68.00/Doz

1



粗沙龙吊 (Qty: 12 Doz x 1 Ctn)

Besi Sarung Buai Epoxy Kasar 17"	S. Price
~	85.00/Doz

2

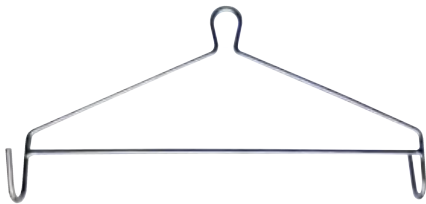

电镀幼沙龙吊 (Qty: 18 Doz x 1 Ctn)

Besi Sarung Buai Krom Halus 14"	S. Price
~	93.00/Doz

3

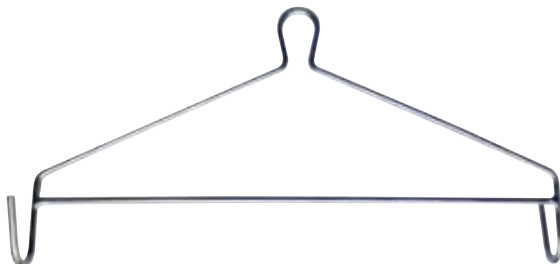

电镀粗沙龙吊 (Qty: 12 Doz x 1 Ctn)

Besi Sarung Buai Krom Kasar 17"	S. Price
~	103.00/Doz

4



50



奶瓶 (Qty: 1 Doz x 12 Ktk)

Botol Susu SMILE BEAR	S. Price
Besar 250ml 大	78.00/Doz
6936551700059	
Kecil 125ml 小	73.20/Doz

1

2



劳工水壶 (Qty: 2 Doz x 6 Bks)

Botol Air Profesor No.6385	S. Price
9555 48350 6385	90.00/Doz

4



50

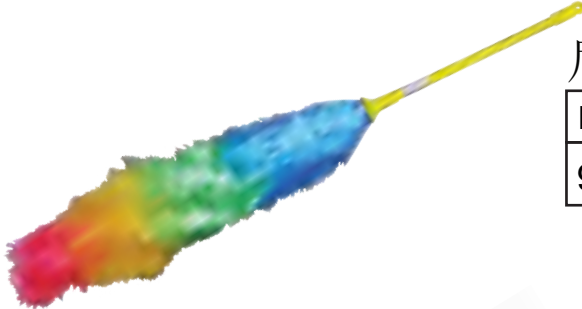

尼龙鸡毛扫 (Qty: 200 Pcs x 1 Ctn)

Bulu Ayam Nylon 80gm	S. Price
9555 48350 5531	3.20/Pcs

2



重型尼龙毛扫 (Qty: 200 Pcs x 1 Ctn)

Bulu Ayam PVC 130G	S. Price
9555 48350 0628	4.50/Pcs

3



纤维鸡毛扫 (Qty: 200 Pcs x 1 Ctn)

Bulu Ayam Fibre 5760	S. Price
9555 48350 5760	4.30/Pcs

5



50



牙签 210gm (12 Ktk x 12 Bks)

Cungkil Gigi Kotak Besar No.230	S. Price
9555 48350 2011	6.50/Ktk

2

牙签 18.5gm (Qty: 3 Doz x 8 Bks)

Cungkil Gigi Kotak Kecil No.300	S. Price
9555 48350 2028	9.60/Doz

3



双头尖尖牙签 50gm (Qty: 2 Doz x 6 Bks)

Cungkil Gigi Tajam No.500	S. Price
9555 48350 2004	16.80/Doz

8



单支包装牙签 (1000 Pcs x 1 Ktk)

Cungkil Gigi Kotak Besar No.230	S. Price
~	8.00/Ktk

5



双头尖 牙签 200g (Qty: 10 Ktk x 12 Bks)

Cungkil Gigi Tajam No.2097	S. Price
9555 48350 2097	6.00/Ktk

9

双头尖高级牙签 (包装)
(Qty: 20 Bks x 24 Pek)

Cungkil Gigi Tajam A413 Berpaket	S. Price
~	1.00/Ktk

13



SIN TAI SOON SDN. BHD. (116948-X)

新大順貿易有限公司

10

50



双头尖高级牙签 (Qty/Ctn: 24 Tin x 12 Box)

Cungkil Gigi Tajam A 171	S. Price
9555 48351 5691	2.40/Pcs

10



双头尖高级牙签 (Qty/Ctn: 24 Tin x 10 Box)

Cungkil Gigi Tajam 295	S. Price
9555 48351 5745	1.80/Tin

11



50



强力黏鼠板 (Qty: 36 Ktk x 20 Pcs)

Gam Tikus Papan SELL	S. Price
9555 48350 1571 (Ktk)	2.90/Pcs
9555 48351 1519 (Pc)	

17



强力黏鼠板 (Qty: 36 Ktk x 20 Pcs)

Gam Tikus Papan KIBI 5660	S. Price
9555 48351 5646 (Ktk)	2.60/Pcs
9555 48351 5560 (Pc)	

24



50



博士牌大象胶水 (Qty/Ctn: 2 Doz x 12 Ktk)

Super Glue Professor 3gm	S. Price
9555 20260 9182	RM 31.20/Doz

4



博士牌大象胶水 (Qty/Ctn: 1 Doz x 12 Ktk)

501 Super Glue Tin Professor 20gm	S. Price
9555 48350 5357	RM 57.60/Doz

20



2 Ton 胶水 (Qty: 12 Pcs x 16 Ktk)

2 Ton Epoxy Gam Dextone	S. Price
8997 01610 0355	RM 9.20/Kad

21



3 Ton 胶水 (Qty: 12 Kad x 12 Ktk)

3 Ton Epoxy Gam TESON	S. Price
9555 13450 2056	RM 10.80/Kad

29

SIN TAI SOON SDN. BHD. (116948-X)

新大順貿易有限公司
12
50

排庄胶水 (Qty: 10 Pcs x 24 Papan)

PVC Gam 14g (Tube)	S. Price
9555 20260 1483	RM 2.00/Pcs

1

黏鞋胶水 (Qty: 12 Pcs x 20 Ktk)

Gam Kasut TESON T-99 20gm	S. Price
9555 13450 2155	RM 4.50/Pcs

9

乌油羔 (Qty: 1 Peti X 24 Tin)

Gam Zink HARDEX	S. Price
9555 48351 6544	RM 10.00/Tin

10

黑油羔卷 (Qty: 6 Roll x 6 Ktk)

Gam Zink Gulung 50mm x 10m	S. Price
9555 20260 0721	RM 26.00/Roll

12

防水止漏贴 (Qty: 12 Roll X 1 Ctn)

Multi Compound Tape Tebal 100cm X 10 Meter	S. Price
9555 48351 6650	RM 41.00/Roll

30-10



50



胶水 (Qty: 12 Tin x 20 Ktk)

GP Dunlop Gam 65ml	S. Price
9555 39580 0205	7.00/Tin

8



铁罐老鼠胶 (Qty : 6 Tin x 12 Ktk x 1 Ctn)

Gam Tikus Tin Besi SELL	S. Price
5517 Besar 大	11.00/Tin
9555 48350 5517	

15



小罐老鼠胶 (Qty: 3 Doz x 4 Ktk)

Gam Tikus Kecil N-Rat 200gm	S. Price
8850 82937 9441	88.00/Doz

27



小罐PVC 胶水 (Qty: 60 Tin x 2 Ctn)

PVC Glue 100g	S. Price
9555 20260 0127	5.70/Pcs

2



50



→ Tangkai Buluh

包庄耳棒 (Qty: 2 Doz x 20 Bks)

Kapas Telinga Bungkus	S. Price
9555 48351 5073	13.60/Doz

3



→ Tangkai Buluh

成人罐庄耳棒 (Qty: 12 Tin x 20 Bks)

Kapas Telinga Tin Dewasa	S. Price
9555 48351 5684	2.20/Tin

4



→ Tangkai Plastik

婴儿罐庄耳棒 (Qty: 12 Tin x 20 Bks)

Kapas Telinga Tin Bayi	S. Price
9555 48351 6124	3.60/Tin

5



50



钢衣勾 (Qty: 60 Pcs x 1 Ctn)

Hanger Dinding Stainless Steel	S. Price
6 S 六头	6.60/Pcs
8 S 八头	10.00/Pcs
10 S 十头	13.40/Pcs

10
11
12



三头向阳花壁勾 (Qty: 160 Pcs x 1 Ctn)

Hanger Dinding Bentuk Sunflower	S. Price
RX301	2.20/Pcs

20



两头蝴蝶壁勾 (Qty: 160 Pcs x 1 Ctn)

Hanger Dinding Bentuk Butterfly	S. Price
RX399	2.20/Pcs

22



六头塑胶黏勾 (Qty: 160 Pcs x 1 Ctn)

Hanger Dinding	S. Price
RX-108	2.20/Pcs

23



50



二头塑胶粘 (Qty: 160 Pcs x 1 Ctn)

Hanger Dinding	S. Price
RX-777 (6923 99410 7774)	RM 2.20/Pcs

24



二头塑胶粘 (Qty: 160 Pcs x 1 Ctn)

Hanger Dinding	S. Price
RX-776 (6923 99410 7767)	RM 2.20/Pcs

25



二头塑胶粘 (Qty: 160 Pcs x 1 Ctn)

Hanger Dinding	S. Price
RX-398 (6931 44390 3983)	RM 2.20/Pcs

31

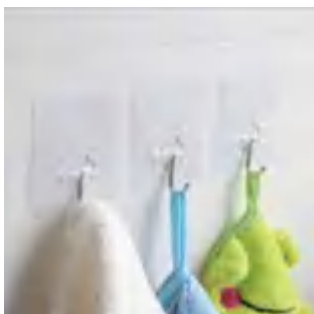

三头方形透明勾 (Qty: 72 Pcs x 1 Ctn)

Hanger Dinding Bentuk 4-Segi	S. Price
9555 48351 6896	RM 2.20/Pcs

32



50



五头塑胶壁勾 (Qty: 160 Pcs x 1 Ctn)

Hanger Dinding	S. Price
RX-320	2.20/Pcs

9



三头塑胶黏勾 (Qty: 160 Pcs x 1 Ctn)

Hanger Dinding	S. Price
RX-612	2.20/Pcs

13



壁勾 (Qty: 160 Pcs x 1 Ctn)

Hanger Dinding	S. Price
RX-220	2.20/Pcs

21



50



10 头壁勾 (12 Kad X 15 Bks)

Hanger Dinding Berpaku 10 Pcs 5838	S. Price
9555 48350 5838	2.80/Kad

26



2头白钢壁勾 (12 Kad X 15 Bks)

Hanger Dinding S/Steel 2 Pcs 5852	S. Price
9555 48350 5852	2.80/Kad

28



不锈钢角码 (12 Kad X 15 Bks)

L Bracket Stainless Steel 40mm X 40mm	S. Price
9555 48350 5869	2.80/Kad

29



单头白钢双壁勾 (12 Kad X 15 Bks)

Hanger Dinding S/Steel Bercabang 1 Pcs 6476	S. Price
9555 48351 6476	2.80/Kad

30



50



三头钢粘勾 (Qty: 240 Kad x 1 Ctn)

Hanger Dinding S/Steel Lekat	S. Price
1308 - 6998 88000 1405	RM 2.00/Kad

33



三头钢粘勾 (Qty: 240 Kad x 1 Ctn)

Hanger Dinding S/Steel Lekat	S. Price
1302 - 6998 88000 1405	RM 2.00/Kad

34



三头钢粘勾 (Qty: 240 Kad x 1 Ctn)

Hanger Dinding S/Steel Lekat	S. Price
1304 - 6998 88000 1405	RM 2.00/Kad

35



三头钢粘勾 (Qty: 240 Kad x 1 Ctn)

Hanger Dinding S/Steel Lekat	S. Price
1307 - 6998 88000 1405	RM 2.00/Kad

36



三头钢粘勾 (Qty: 240 Kad x 1 Ctn)

Hanger Dinding S/Steel Lekat	S. Price
1309 - 6998 88000 1405	RM 2.00/Kad

37



50



(Qty: 50 Pek x 20 Ktk)

1803-L	S. Price
~	0.50/Pek

6



(Qty: 50 Pek x 20 Ktk)

1803-M	S. Price
~	0.50/Pek

7



50



1803-LSY	S. Price
No.25 (1 Ctn x 200 Pek)	1.40/Pek
No. 100 (1 Ctn x 50 Pek)	3.50/Pek

12
14

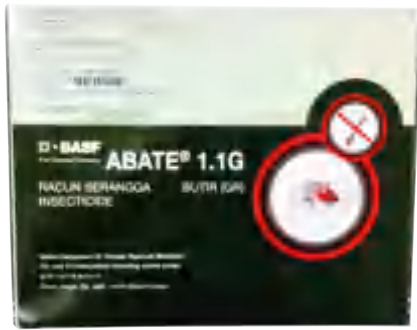

子子药

ABATE 10 x 10g	S. Price
10 Pek x 24 Ktk x 1 Ctn	36.00/Ktk

13



(Qty: 2 Doz X 15 Bks)

1803-Thai	S. Price
	24.00/Doz

15



(Qty: 1 Kg X 10 Bks)

1803-KG	S. Price
1 Kg	50.00/Bks

16



50



25"短锡纸 (Qty: 24 Pcs x 5 Ctn)

Kertas Aluminium Crystal Crown Pendek	S. Price
9555 48350 5326	7.40/Pcs

17



37.5"长锡纸 (Qty: 24 Pcs x 5 Ctn)

Kertas Aluminium Crystal Crown Panjang	S. Price
9555 48350 5050	10.90/Pcs

18



50



铝箔自助餐盘 (Qty/Ctn: 60 Set x 1 Ctn)

Aluminium Tray Segiempat 4 Pcs 20.5cm x 20.5cm x 4cm	S. Price
9555 48351 5752	7.30/Set

23

铝箔自助餐盘 (Qty/Ctn: 60 Set x 1 Ctn)

Aluminium Tray Segiempat 4 Pcs 22cm x 16cm x 4cm	S. Price
9555 48351 5769	7.30/Set

24

铝箔自助餐盘 (Qty/Ctn: 60 Set x 1 Ctn)

Aluminium Tray Bulat 4 Pcs 22cm x 4cm	S. Price
9555 48351 5776	7.30/Set

25

铝箔自助餐盘 (Qty/Ctn: 60 Set x 1 Ctn)

Aluminium Tray Bulat 3 Pcs 31.3cm x 22cm x 5cm	S. Price
9555 48351 5783	7.30/Set

26



50



创新指甲剪 (Qty: 1 Doz x 50 Ktk)

Kepit Kuku N0817A-8	S. Price
9555 48351 6179	27.60/Doz

4



创新指甲剪 (Qty: 1 Doz x 50 Ktk)

Kepit Kuku N-395A-3	S. Price
9555 48351 6186	42.00/Doz

5



创新指甲剪 (Qty: 1 Doz x 50 Ktk)

Kepit Kuku N-403A-7	S. Price
9555 48351 6193	34.80/Doz

8



创新指甲剪 (Qty: 1 Doz x 50 Ktk)

Kepit Kuku N-0818AC-3B	S. Price
9555 48351 6117	38.00/Doz

9



SIN TAI SOON SDN. BHD. (116948-X)

新大順貿易有限公司

18

50



创新指甲剪 (Qty: 1 Doz x 50 Ktk)

Kepit Kuku 104	S. Price
104-9555 48351 6926	RM 36.00/Doz

1



创新指甲剪 (Qty: 1 Doz x 100 Ktk)

Kepit Kuku N-807	S. Price
9555 48351 6230	RM 10.80/Doz

2



创新指甲剪 (Qty: 1 Doz x 50 Ktk)

Kepit Kuku N-0818B	S. Price
9555 48351 6100	RM 24.00/Doz

3



50



硫磺 (Qty: 10 Pek x 5 Bks)

Serbuk Belerang (500gm)	S. Price
9555 48350 5104	RM 6.00/Pek

4



小苏打 (Qty: 6 Pek x 12 Btl)

Serbuk Soda Serbaguna KIBI	S. Price
600g - 9555 48351 6490	RM 8.40/Btl
400g - 9555 48351 6506	RM 6.40/Btl

56



洗地粉 (Qty: 20 Pek x 5 Bks) (180gm)

Serbuk Cuci Lumut Professor	S. Price
9555 48350 5579	RM 2.80/Pek

1



洗地粉 (Qty: 6 Pek X 12 Btl)

Serbuk Cuci Lumut KIBI	S. Price
550g - 9555 48351 6513	RM 9.60/Btl

8

50

洗衣机槽洁泡片 (Qty: 6 Pek X 12 Btl)

Pembersih Tangki Mesin Basuh Baju	S. Price
9555 48351 6537	RM 8.00/Btl

9

堵塞清除剂 (粉庄) (Qty: 6 Pek X 12 Btl)

CR-2880 (Serbuk)	S. Price
	RM 8.00/Btl

10

堵塞清除剂 (水庄) (Qty: 3 Ctn X 24 Btl)

Penghapus Sumbat DOA-700 (Cecair)	S. Price
9555 48351 6933	RM 16.60/Btl

13



50



船灯 (Qty: 30 Pcs X 1 Ctn)

Lampu Ayam	S. Price
No.235 Kecil 小	27.00/Pcs
9555 48351 5837	

4

船灯 (Qty: 24 Pcs X 1 Ctn)

Lampu Ayam	S. Price
No.255 Besar 大	31.60/Pcs
9555 48351 5820	

5



五号壁灯 (Qty: 90 Pcs X 1 Ctn)

Lampu No.5	S. Price
9555 48351 5813	16.50/Pcs

6



50



生胶打鸟带 (Qty: 100 Pcs x 20 Pek x 1 Ctn)

Tali Lastik Gred A Erawan 1.5kg	S. Price
200000012411	126.00/Pek

6



生胶扁打鸟带 Qty: 100 Pcs 15 Ktk x 1 Ctn

Getah Lastik Leper X-10	S. Price
2.4 kg	236.00/Ktk

8



23寸打鸟带 (Qty: 50 Pcs x 12 Bks)

Lastik Tube 23" Nipis	S. Price
9555 48350 5388	2.60/Pcs

11

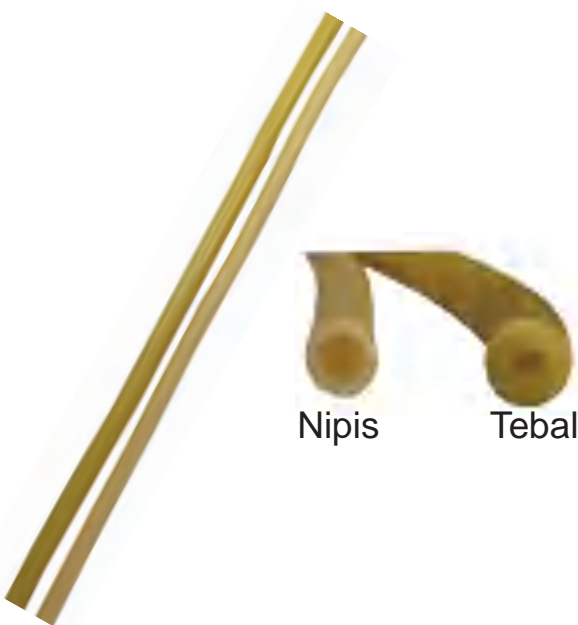

23寸加厚打鸟带 (Qty: 10 Pcs x 12 Bks)

Lastik Tube 23" Tebal	S. Price
9555 48351 6643	10.00/Pcs

14



50



套庄胶柄打鸟带 (Qty: 10 Set x 20 Bks)

Lastik Set Tangkai Plastik	S. Price
9555 48350 0604	4.00/Set

1



打鸟柄 (Qty: 500 Pcs x 1 Ctn)

Cabang Lastik	S. Price
	0.80/Pcs

3

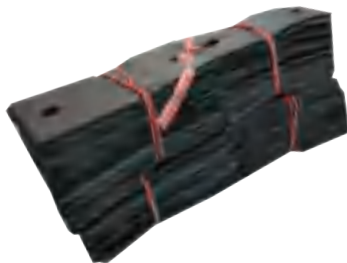

打鸟皮带 (Qty: 100 Pcs x 10 Ikat)

Kulit Getah Lastik	S. Price
9555 75261 6612	0.30/Pcs

13



50



十二头灯芯 (Qty: 10 Pcs x 30 Bks)

Sumbu Pelita Raya	S. Price
~	RM 7.20/Pcs

4



铁马来灯包灯芯

(Qty: 8 Pcs x 20 Pek x 12 Ctn)

Pelita Raya Besi Siap Sumbu 8's	S. Price
9555 48350 9669	RM 2.90/Pcs

2



塑胶马来灯包灯芯

(Qty: 8 Pcs x 20 Pek x 12 Ctn)

Pelita Raya Plastik Siap Sumbu 8's	S. Price
9555 48351 5110	RM 1.32/Pcs

7



五号灯芯 (Qty: 20 Pcs x 20 Bks)

Sumbu Lampu No.5	S. Price
9555 48351 5370	RM 16.00/Bks

8



50



原装燃气火炬 (Qty: 10 Pcs X 10 Ktk)

Obor Gas Butana Taiwan	S. Price
WS-503C (9555483515547)	24.00/Pcs

1



燃气火炬 (Qty: 10 Pcs X 10 Ktk)

Obor Gas Butana China	S. Price
WS-503C (9555483505814)	20.00/Pcs

2



打火枪 (Qty: 144 Pcs)

Pistol Gas Lighter Panjang YEEPI	S. Price
9555 002 111113 (Pc)	4.20/Pcs
9555 002 200008 (Ktk)	

3



铁打火枪 (Qty: 12 Pcs X 12 Ktk)

Pistol Gas Spark Besi	S. Price
27cm - 6903 32822 6531	10.80/Pcs
35cm - 4544 99900 0208	13.80/Pcs

4

11



50



防风打火机 (Qty: 12 Pcs x 12 Ktk)

Lighter Jet Flame VM258-C	S. Price
9555 96200 0748	RM 10.00/Pcs

5



防风打火机 (Qty: 20 Pcs x 16 Ktk)

Mini Lighter Jet Flame VM263WP-CT	S. Price
9555 96200 0151	RM 6.20/Pcs

12



(Qty: 12 Pcs x 8 Ktk)

Lighter Gas Refill YEEPI 300ml	S. Price
766150125221	RM 96.00/Doz

8



(Qty: 25 Pcs x 20 Ktk)

Lighter Gas Refill STAR FIRE 18ml	S. Price
9555 96200 0106	RM 2.00/Pcs

9



50

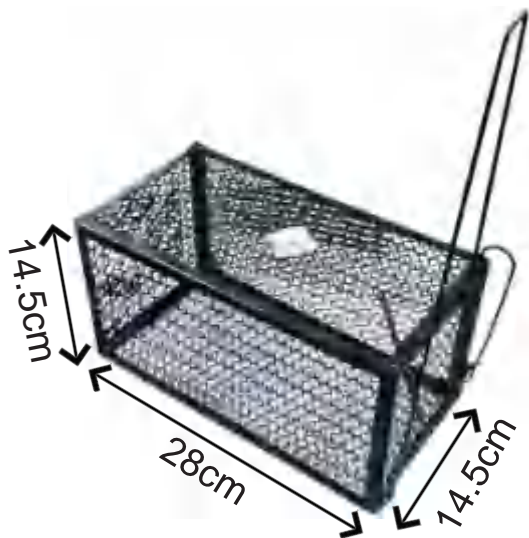

黑老鼠笼 (Qty: 10 Pcs x 10 Ktk)

Sangkar Tikus Hitam KIBI	S. Price
9555 48351 5899	13.00/Pcs

3



50



1500象标加厚黑布手套 (Qty: 18 Doz x 1 Ctn)

Sarung Tangan Tebal Kain Hitam Gajah Bumi	S. Price
9555 48350 0871	24.00/Doz

32



本地象标布手套 (Qty: 30 Doz x 1 Ctn)

Sarung Tangan Kain Cap Gajah Bumi 1200(Local)	S. Price
9555 48351 5950	21.80/Doz

34



牛皮手套 (Qty: 10 Doz x 1 Ctn)

Sarung Tangan Welding Kulit Lembu 13"	S. Price
9555 48350 5906	173.00/Doz

43





50

800gm



鸡标红布手套 (Qty/Ctn: 40 Doz x 10 Ctn)

Sarung Tangan Kain Merah	S. Price
1200 Ayam	12.00/Doz
9555 48351 5127	

13



900gm



马标红布手套 (Qty/Ctn: 40 Doz x 5 Ctn)

Sarung Tangan Kain Merah	S. Price
1200 Kuda	15.60/Doz
9555 48351 5080	

5



900gm



马标黄布手套 (Qty/Ctn: 40 Doz x 1 Ctn)

Sarung Tangan Kain Kuning Kuda	S. Price
1200 Kuda	18.00/Doz
9555 48351 5080	

6



50



灰纱粘胶手套 (Qty: 12 Psg x 18 Bks)

Sarung Tangan Rubber Grip SUPA	S. Price
1800 - 9555 48350 0925	RM 4.80/Psg

29



灰纱粘胶手套 (Qty: 12 Psg x 18 Bks)

Sarung Tangan Rubber Grip SUPA	S. Price
2000 - 9555 48351 6742	RM 4.00/Psg

46



单面胶点手套 (Qty: 50 Bks x 1 Doz)

Sarung Tangan Bintik Sebelah	S. Price
1200	RM 17.20/Doz

4

550gm



马标黄布手套 (Qty : 50 Doz x 3 Ctn)

Sarung Tangan Kain Kuning Kuda	S. Price
550 - 9555 48351 5097	RM 10.80/Doz

3



50
盒装手术手套 (Qty: 10 Ktk x 2 Ctn)

Latex Disposable Glove Putih	S. Price
Size L	RM 27.00/Ktk
Size M	RM 27.00/Ktk
Size S	RM 27.00/Ktk

18-P
19-P
20-P
盒装手术手套 (Qty: 10 Ktk x 2 Ctn)

Nitrile Disposable Glove Biru	S. Price
Size L	RM 27.00/Ktk
Size M	RM 27.00/Ktk
Size S	RM 27.00/Ktk

18-B
19-B
20-B
盒装手术手套 (Qty: 10 Ktk x 2 Ctn)

Nitrile Disposable Glove Hitam	S. Price
Size L	RM 27.00/Ktk
Size M	RM 27.00/Ktk
Size S	RM 27.00/Ktk

18-HT
19-HT
20-HT

一次性塑料手套 (Qty: 72 Ktk x 2 Ctn)

KIBI Disposable PE Gloves 175g (100 Pcs/Ktk)	S. Price
9555 48350 5913	RM 6.40/Box

24
一次性塑料手套
(Qty: 10 Box x 10 Bks x 100 Pcs)

Sarung Tangan Plastik (1000 Pcs/Ktk)	S. Price
	RM 26.00/Box

25

包装手术手套 (Qty: 12 Pek x 18 Bks)

Latex Disposable Glove 8's	S. Price
9555 48350 5395	RM 3.50/Pek

17

盒装手术手套 (Qty: 10 Pek x 18 Bks)

Nitrile Disposable Glove 10's	S. Price
Hitam - 9555 48350 9539	RM 4.00/Pek
Biru - 9555 48350 9522	RM 4.00/Pek

17-HT
17-B



50



12寸玫瑰橡胶手套 (Qty: 1 Doz x 10 Bks)

Sarung Tangan Rose 12"	S. Price
9555 48350 5067	59.00/Doz

31



12寸红色橡胶手套 (Qty: 1 Doz x 10 Bks)

Sarung Tangan Getah Merah Cap Flower 12"	S. Price
No. 5944 (9555 48350 5944)	48.00/Doz

35



十五寸玫瑰橡胶手套 (Qty: 1 Doz x 10 Bks)

Sarung Tangan Rose Panjang Cap Flower 15"	S. Price
9555 48350 5074	72.00/Doz

27



1.2kg

黑胶手套 (Qty: 1 Doz x 10 Bks)

Sarung Tangan Getah Hitam Cap Gajah Bumi	S. Price
9555 48350 0468	51.00/Doz

33



30

50



马标布手套 (Qty: 12 Pek x 18 Bks)

Sarung Tangan Kain 1200	S. Price
1 x 2 Psg - 9555483515721	2.80/Pek

38



马标布手套 (Qty: 12 Pek x 18 Bks)

Sarung Tangan Kain 550	S. Price
1 x 2 Psg - 9555483515998	2.40/Pek

40



马标布手套 (Qty: 18 Doz x 1 Ctn)

Sarung Tangan Kain 550	S. Price
1 x 3 Psg - 9555483516001	3.40/Pek

41



50



耐油手套 (Qty: 12 Psg x 3 Bks)

Sarung Tangan Kalis Minyak & Tahan Licin 6599	S. Price
9555 48351 6599	10.00/Psg

44



粗面耐油手套 (Qty: 12 Psg x 3 Bks)

Sarung Tangan Kalis Minyak Kasar & Tahan Licin 6605	S. Price
9555 48351 6605	11.00/Psg

45



摩多手套 (Qty: 25 Doz x 1 Ctn)

Sarung Tangan Motor Berlogo	S. Price
~	52.80/Doz

21



50



去锈膏 (Qty: 24 Pcs x 12 Box)

Autosol 50gm	S. Price
	13.50/Pcs

1



50

晒衣索 (Qty: 1 Doz x 24 Bks)



Tali Ampaian	S. Price
5 Meter - 9555 48350 5401	17.50/Doz
12 Meter - 9555 48350 5968	29.80/Doz

11
10



圆脚车带

Tali Basikal Bulat Thailand	S. Price
No. 3 - 27" (1 Doz x 50 Bks)	19.20/Doz
No. 5 - 48" (1 Doz x 30 Bks)	30.00/Doz
No. 8 - 63" (1 Doz x 30 Bks)	36.00/Doz

3
13
14



2.3米双勾黑脚车带 20Pcs X 5 Ikat

Tali Basikal Hitam	S. Price
2.3 Meter	RM5.50/PCS

5



50



沙篱甲利 (MOQ: 30 Bks)

Sudu Getah Zink 4kg \pm	S. Price
9555 48350 0871	RM 66.00/Bks

3



老树沙厘甲利 (MOQ: 30 Bks)

Sudu Getah Tua Zink Berpacking 2kg \pm	S. Price
9555 48351 6735	RM 32.60/Bks

5



50



一米补铝羔 (Qty: 15 Pcs x 24 Bks)

Tampal Periuk 1 Meter	S. Price
1 Bungkus x 15 Pcs	2.70/Pcs
9555 48350 5647	

3



补铝羔 (Qty: 36 Pcs x 1 Ctn)

Tampal Periuk Aluminium (China)	S. Price
48mm x 25 Meter	15.00/Pcs
9555 48351 6391	

5



补铝羔 (Qty: 10 Papan x 1 Ctn)

Tampal Periuk 10" SIAP Kertas Pasir 48's	S. Price
9555 48351 6339	72.00/Ppn

8



50

原子草席



Tikar Plastik	S. Price	
3 x 6 (Qty: 60 Pcs x 1 Ctn)	19.20/Pcs	2
9555 48351 5400		
6 x 6 (Qty: 30 Pcs x 1 Ctn)	41.00/Pcs	3
9555 48351 5417		
6 x 9 (Qty: 24 Pcs x 1 Ctn)	64.00/Pcs	4
9555 48351 5424		
9 x 9 (Qty: 15 Pcs x 1 Ctn)	103.00/Pcs	5
9555 48351 5431		
9 x 12 (Qty: 12 Pcs x 1 Ctn)	140.00/Pcs	6
9555 48351 5448		



折型塑料草席 (Qty: 5 Pcs x 18 Ikat)

Tikar Plastik Lipat	S. Price	
52" x 68"	29.50/Pcs	9



50



维他命树油 (Qty: 40 Btl x 1 Ctn)

Vitamin Penggalak Susu Getah Hijau 500ml	S. Price
5%	RM 17.00/Btl

19



维他命树油 (Qty: 30 Btl x 1 Ctn)

Vitamin Penggalak Susu Getah Merah 500ml	S. Price
10%	RM 19.00/Btl

20



保养树油 (Qty: 30 Btl x 1 Ctn)

Sp Upgrade Penaik Taraf Susu Getah 500ml	S. Price
	RM 42.00/Btl

21



风梨油 (Qty: 20 Btl x 2 Ctn)

Ubat Minyak Nanas	S. Price
~	RM 11.00/Btl

9



50



青树油 (Qty: 40 Btl x 2 Ctn)

Penggalak Susu Getah Hijau 500ml	S. Price
5% - 9555 48350 5661	RM 8.60/Btl

3



白树油 (Qty: 40 Btl x 2 Ctn)

Penggalak Susu Getah Putih 500ml	S. Price
5%	RM 8.60/Btl
10%	RM 11.60/Btl

4

6



红树油 (Qty: 40 Btl x 2 Ctn)

Penggalak Susu Getah Merah 500ml	S. Price
10%	RM 11.60/Btl

5



紫树油 Qty: 40 Btl x 2 Ctn)

Penggalak Susu Getah Ungu 500ml	S. Price
22%	RM 13.80/Btl

18



50



蚊帳 (Qty: 6 Pcs x 10 Bks)

Kelambu Nyamuk	S. Price
3 Kaki - 9555 48351 6315	14.00/Pcs
6 Kaki - 9555 48351 6322	22.00/Pcs

3
4

50

扁蚊香盒 (Qty: 10 Doz x 1 Ctn)

Tin Nyamuk Leper	S. Price
9555 48351 5455	RM 60.00/Doz

1

高蚊香盒 (Qty: 10 Doz x 1 Ctn)

Tin Nyamuk Tinggi	S. Price
~	RM 63.00/Doz

2



SIN TAI SOON SDN. BHD. (116948-X)

新大順貿易有限公司

41

50



辣椒标火柴 (Qty: 12 Bkgs X 3 Ctn)

Mancis Lada	S. Price
9557 82403 2317	RM 60.00/Bkgs

1



SIN TAI SOON SDN. BHD. (116948-X)

新大順貿易有限公司

42

50



玻璃球 (Qty: 50 Ktk x 5 Peti)

Guli Kecil 80's ±	S. Price
9555 48351 6568	RM 3.50/Ktk

4

SIN TAI SOON SDN. BHD. (116948-X)
新大順貿易有限公司
44
50
鸡饮水器

Bekas Minuman Ayam	S. Price
Kecil (小) No.6911 Qty: 24 Pcs x 1 Ctn	5.25/Pcs
Sedang (中) No.6912 Qty: 16 Pcs x 1 Ctn	11.20/Pcs
Besar (大) No.6913 Qty: 9 Pcs x 1 Ctn	16.70/Pcs

30
31
32
鸡食料器

Bekas Minuman Ayam	S. Price
Kecil (小) No.6917 Qty: 36 Pcs x 1 Ctn	9.20/Pcs
Besar (大) No.6918 Qty: 30 Pcs x 1 Ctn	11.00/Pcs

33
34



50



鱼钩 (Qty: 30 Pek x 10 Papan) (Campur Saiz)

Mata Kail 1902 Siap Papan 30's	S. Price
9555 48350 4992	RM 2.90/Pek

20



虾钩 (Qty: 30 Pek x 10 Papan) (Campur Saiz)

Mata Kail Udang Siap Papan 30's	S. Price
9555 48351 6766	RM 2.90/Pek

60



转环 (Qty: 30 Pek x 10 Papan) (Campur Saiz)

Kili Siap Papan 30's	S. Price
9555 48351 6759	RM 3.10/Pek

21



50

鱼珠 (Qty: 100 Pcs x 3 Bks)



Batu Pancing	S. Price	
No. 1	RM 0.28/Pcs	14
No. 2	RM 0.40/Pcs	15
No. 3	RM 0.50/Pcs	16
No. 4	RM 0.85/Pcs	17
No. 5	RM 1.00/Pcs	18
No. 6	RM 1.80/Pcs	19

鱼珠 (Qty: 10 Pek x 5 Bks)



Batu Pancing Tanpa Papan	S. Price	
No. 1 (6 Pcs) - 9555 48350 9997	RM 2.90/Pek	14-P
No. 2 (4 Pcs) - 9555 48350 9980	RM 2.90/Pek	15-P
No. 3 (3 Pcs) - 9555 48350 9973	RM 2.90/Pek	16-P
No. 4 (2 Pcs) - 9555 48350 9966	RM 2.90/Pek	17-P
No. 5 (2 Pcs) - 9555 48350 9959	RM 2.90/Pek	18-P
No. 6 (1 Pcs) - 9555 48350 9942	RM 2.50/Pek	19-P

鱼珠 (Qty: 25 Pek x 10 Papan) (Campur Saiz)



Batu Pancing Siap Papan 25's	S. Price	
9555 48351 7008	RM 3.10/Pek	40



50

鱼钩 (Qty: 10 Pek x 5 Bks)



Mata Kail 1902 Tanpa Papan	S. Price	
No. 6 - 9555 48351 5172	RM 2.70/Pek	76
No. 7 - 9555 48351 5189	RM 2.70/Pek	77
No. 8 - 9555 48351 5196	RM 2.70/Pek	78
No. 9 - 9555 48351 5202	RM 2.70/Pek	79
No. 10 - 9555 48351 5219	RM 2.70/Pek	80
No. 11 - 9555 48351 5226	RM 2.70/Pek	81
No. 12 - 9555 48351 5233	RM 2.70/Pek	82
No. 13 - 9555 48351 5240	RM 2.70/Pek	83
No. 14 - 9555 48351 5257	RM 2.70/Pek	84
No. 15 - 9555 48351 5264	RM 2.70/Pek	85

虾钩 (Qty: 10 Pek x 5 Bks)



Mata Kail Udang Tanpa Papan	S. Price	
No. 1 - 9555 48351 6834	RM 2.70/Pek	33
No. 2 - 9555 48351 6841	RM 2.70/Pek	34
No. 3 - 9555 48351 6858	RM 2.70/Pek	35
No. 4 - 9555 48351 6865	RM 2.70/Pek	36
No. 5 - 9555 48351 6872	RM 2.70/Pek	37

转环 (Qty: 10 Pek x 5 Bks)



Kili Tanpa Papan	S. Price	
No. 2 - 9555 48351 6773	RM 2.90/Pek	31
No. 4 - 9555 48351 6780	RM 2.90/Pek	32
No. 6 - 9555 48351 6797	RM 2.90/Pek	27
No. 8 - 9555 48351 6803	RM 2.90/Pek	28
No. 10 - 9555 48351 6810	RM 2.90/Pek	29
No. 12 - 9555 48351 6827	RM 2.90/Pek	30



50



(Qty: 60 Pek x 10 Papan) (Campur Saiz)

Tali Tangsi SIAP PAPAN	S. Price
9555 48351 6988	RM 78.00/Papan

54



50

泰国渔网 (Qty: 10 Pcs x 3 Bks)

Jaring Ikan Thailand	S. Price	
30 X 30 X 6A - 9555483509720	RM 28.00/Pcs	3
35 X 30 X 6A - 9555483509737	RM 28.00/Pcs	4
40 X 30 X 6A - 9555483509744	RM 27.00/Pcs	5
45 X 30 X 6A - 9555483509751	RM 27.00/Pcs	6
50 X 30 X 6A - 9555483509768	RM 27.00/Pcs	7
55 X 30 X 6A - 9555483509775	RM 27.00/Pcs	8
60 X 30 X 6A - 9555483509782	RM 27.00/Pcs	9
65 X 30 X 6A - 9555483509799	RM 27.00/Pcs	10
70 X 30 X 6A - 9555483509676	RM 27.00/Pcs	11
80 X 30 X 6A - 9555483509560	RM 27.00/Pcs	92



尼龙绳 (Qty: 10 Bks X 1 Kg) (Campur Size)

Tali Jala Hijau 1 Kg (10's) Double Elephant	S. Price	
380 / 15 - 9555 48350 9683	RM 40.00/Bks	87-DE
380 / 21 - 9555 48350 9690	RM 40.00/Bks	88-DE
380 / 36 - 9555 48350 9706	RM 40.00/Bks	89-DE
380 / 45 - 9555 48350 9713	RM 40.00/Bks	90-DE



尼龙绳 (Qty: 10 Bks X 1.3 Kg) (Campur Size)

Tali Jala Hijau 1.3kg 20's	S. Price	
380 / 15 - 8854445 273251	RM 60.00/Bks	87
380 / 36 - 8854445 435130	RM 60.00/Bks	89
380 / 48 - 8854445 273251	RM 60.00/Bks	90
380 / 60 - 8854445 273275	RM 60.00/Bks	86





50

(Qty: 30 Pek x 3 Bks)

Tali Tangsi Biru Halus	S. Price
No. 8 - 9555 48350 9812	RM 0.80/Pek
No. 10 - 9555 48350 9829	RM 0.80/Pek
No. 12 - 9555 48350 9904	RM 0.80/Pek
No. 15 - 9555 48350 9836	RM 1.10/Pek
No. 20 - 9555 48350 9843	RM 1.10/Pek
No. 25 - 9555 48350 9850	RM 1.10/Pek

41-B
42-B
55-B
43-B
44-B
45-B



(Qty: 30 Pek x 2 Bks)

Tali Tangsi Biru Kasar	S. Price
No. 30 - 9555 48350 9867	RM 1.60/Pek
No. 35 - 9555 48350 9911	RM 1.60/Pek
No. 40 - 9555 48350 9874	RM 1.60/Pek
No. 45 - 9555 48350 9928	RM 2.00/Pek
No. 50 - 9555 48350 9881	RM 2.00/Pek
No. 60 - 9555 48350 9898	RM 2.00/Pek

46-B
56-B
47-B
57-B
48-B
49-B



(Qty: 60 Pek x 10 Papan) (Campur Saiz)

Tali Tangsi Biru SIAP PAPAN	S. Price
Halus - 9555 48351 7541	RM 78.00/Papan
Kasar - 9555 48351 7558	RM 126.00/Papan

54-H
54-K



50

钓鱼浮漂 (Qty: 10 Pek x 5 Bks)



Pelampung Pancing	S. Price
3g 2's - 9555 48350 9607	RM 3.10/Pek
5g 2's - 9555 48350 9614	RM 3.10/Pek
8g 2's - 9555 48350 9621	RM 3.10/Pek

70

71

72

钓鱼浮漂 (Qty: 10 Pek x 5 Bks)

Pelampung Pancing	S. Price
10g 2's - 9555 48350 9638	RM 3.45/Pek
12g 2's - 9555 48350 9645	RM 3.45/Pek
15g 2's - 9555 48350 9652	RM 3.45/Pek

73

74

75



排装钓鱼浮漂

(Qty: 32 Pek x 10 Papan) (Campur Saiz)

Pelampung Pancing SIAP PAPAN 32's	S. Price
9555 48350 9584	RM 3.30/Pek
9555 48350 9577	RM 3.65/Pek

61-K

61-B



50



-35%

胶圈三层口罩(盒庄) (Qty: 50 Pcs x 40 Ktk x 1 Ctn)

Face Mask Getah-CN (3 Ply)/Kotak	S. Price
9555 48350 5555	RM 6.60/Ktk

1



-35%

本地医疗三层口罩 (Qty: 50 Pcs x 50 Ktk x 2 Ctn)

MDA Face Mask Getah (3 Ply)/Kotak (Made In Malaysia)	S. Price
9555 48350 9935	RM 11.00/Ktk

1-M



-40%

五层口罩 (Qty: 10 Pcs X 20 Pkt X 10 Bks)

Face Mask KN 95	S. Price
9555 48351 6629	RM 5.00/Pkt

21



-40%

4层口罩 (Qty: 10 Pcs X 20 Pkt X 10 Bks)

Face Mask KF 94	S. Price
PUTIH (9555 48351 6704)	RM 4.00/Pkt
HITAM (9555 48351 6698)	RM 4.00/Pkt

**24-P
24-HT**



50



日本防尘口罩 (Qty: 12 Doz x 1 Ctn)

Dust-Proof Mask 201 Jepun	S. Price
9555 48351 5158	60.00/Doz

5



无纺布浴帽 (Qty: 100 Pcs x 20 Bks)



Mob Cap	S. Price
~	0.25/Pcs

8





50



电池水 (Qty: 25 Pcs x 4 Ctn)

Air Bateri	S. Price
9555 48350 5593	RM 3.60/Pcs

1

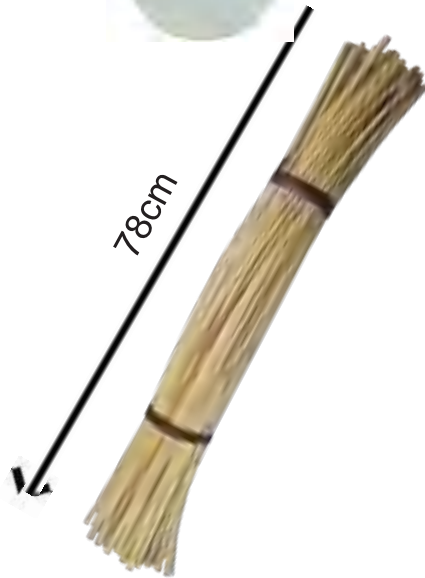

藤条 (Qty: 100 Pcs x 10 Ikat)

Rotan	S. Price
~	0.85/Pcs

19



50



一次性围裙 (Qty: 10 Pek x 100 Pcs)

Disposable Apron 120cm x 76cm	S. Price
~	RM 30.00/Pek

10



一次性围裙 (Qty: 18 Pcs x 20 Pek x 8 Bks)

Apron Pakai Buang KIBI Berpacking 120cm x 76cm	S. Price
9555 48351 6964	RM 6.40/Pek

112



化学防护围裙 (Qty: 10 Pcs x 12 Pek)

Apron Meraacun	S. Price
9555 48350 9553	RM 14.00/Pcs

113





50



自助餐蜡烛 (Qty: 24 Pek x 1 Ctn)

Lilin Buffet 100's	S. Price
850gm± (9555 13580 0076)	27.60/Pek

13



苍蝇蜡烛 (Qty: 66 Set x 1 Ctn)

Lilin Serai Anti-Lalat 2's	S. Price
9555 48351 5714	11.00/Set

99



苍蝇蜡烛 (Qty: 66 Set x 1 Ctn)

Lilin Serai Anti-Lalat 20's	S. Price
9555 48350 5968	12.00/Pcs

107



50

博士牌蜡烛 (Qty: 50 Ktk x 10 Ctn)

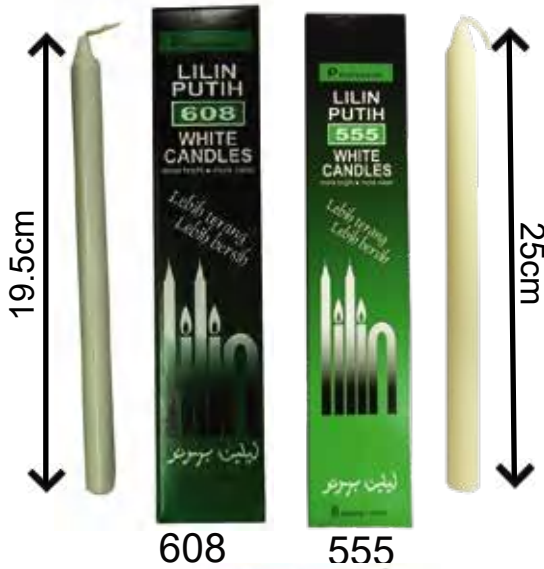

Lilin Professor	S. Price
608 7.5kg±	RM 132.00/Ctn
9555 48350 5548	
555 13.0kg±	RM 220.00/Ctn
9555 48350 5982	

12

39



博士牌蜡烛 (Qty: 50 Ktk x 10 Ctn)

Lilin Professor 333	S. Price
10.5kg± (9555 48351 5332)	RM 186.00/Ctn

82



四寸博士牌洋烛 (Qty: 150 Ktk x 2 Ctn)

Lilin Professor 101	S. Price
20.4kg± (9555 48350 5975)	RM 468.00/Ctn

62



驱蚊蜡烛 (Qty: 50 Ktk x 4 Ctn)

Lilin Serai Penghalau Serangga	S. Price
10kg± (9555 48350 9805)	RM 310.00/Ctn

42



50



防爆火锅瓦斯 (Qty: 4 Pcs x 7 Pek x 10 Ctn)

Gas Steamboat Kalis Letupan	S. Price
9551 01897 0355	RM 6.40/Pcs

41



火锅瓦斯 (Qty: 4 Pcs x 7 Pek x 10 Ctn)

Gas Steamboat Tanpa Kalis Letupan	S. Price
9551 01897 0539	RM 6.00/Pcs

41-F



杏仁扇 (Qty: 200 Pcs x 1 Ctn)

Kipas Sate	S. Price
~	RM 4.10/Pcs

44



50



中国铁老鼠夹 (Qty: 10 Doz x 1 Ctn)

Sepit Tikus	S. Price
9555 48351 6056	RM 27.60/Doz

26



钢平底深盘

Pinggan S/Steel	S. Price
24cm - 9555 48351 5844	RM 4.00/Pcs
200 Pcs	
26cm - 9555 48351 5851	RM 4.60/Pcs
200 Pcs	
28cm - 9555 48351 5868	RM 5.40/Pcs
200 Pcs	

21

70

101



50



单骨银色长雨伞

Payung Color Silver Rangka Single	S. Price
24" K226UV (9555 48350 5470) (Qty: 6 Pcs x 14 Ikat)	RM 18.00/Pcs
27" K300UV (9555 48350 5463) (Qty: 6 Pcs x 14 Ikat)	RM 24.00/Pcs
30" K112 (9555 48350 5456) (Qty: 6 Pcs x 8 Ikat)	RM 27.80/Pcs

53

54

55



双骨银色长雨伞 (Qty: 6 Pcs x 10 Ikat)

Payung Color Silver Rangka Double	S. Price
27" K508UV (9555 48350 5487)	RM 33.00/Pcs

56

银色折雨伞

Payung Lipat Color Silver	S. Price
21" K330UV (9555 48350 5494) (Qty: 6 Pcs x 20 Ikat)	RM 18.00/Pcs
30" K880UV (9555 50040 0337) (Qty: 12 Pcs x 5 Ikat)	RM 26.50/Pcs

57

104

银色折雨伞 (Qty: 12 Pcs x 5 Ikat)

Payung Lipat Colour Silver Auto	S. Price
21" K350	RM 26.50/Pcs

105





SIN TAI SOON SDN. BHD. (116948-X)

新大順貿易有限公司

200

50



参色厚庄加裤雨衣 (Qty: 40 Pcs x 1 Ctn)

Baju Hujan Tebal Berseluar Campur Warna	S. Price
9555 48351 5677	RM 25.60/Pcs

37



参色无裤雨衣 (Qty: 48 Pcs x 1 Ctn)

Baju Hujan Tanpa Seluar Campur Warna (AB 019)	S. Price
9555 48350 0901	RM 13.60/Pcs

68



一次性雨衣 (Qty: 250 Pcs x 1 Ctn)

Baju Hujan Disposable Campur Warna	S. Price
6972 21223 0114	RM 3.00/Pcs

111



50



加厚塑料围巾 (1.1 Meter) (Qty: 5 Pcs x 12 Bks)

Apron PVC Tebal	S. Price
KUNING (9555 48350 5432)	13.00/Pcs
BIRU (9555 48350 5449)	

63-K
63-B

家私皮围裙 (Qty: 5 Pcs x 12 Bks)

Apron PVC Sofa	S. Price
80cm - 9555 48351 5141	6.60/Pcs
1 Meter - 9555 48351 5134	8.00/Pcs
1.1 Meter - 9555 48351 5516	9.30/Pcs

73
74
87

胶棒 (Qty: 25 Kad x 10 Bks)

Glue Stick 18cm X 14's	S. Price
9555 48351 6636	4.00/Kad

84



胶枪 (Qty: 6 pcs x 16 Bks)

Glue Gun	S. Price
8681 76390 1029	12.00/Pcs

85

SIN TAI SOON SDN. BHD. (116948-X)

新大順貿易有限公司
200
50

S勾 (Qty: 12 Pek x 12 Ktk)

Penyangkut S SUPA	S. Price	
2.5" (No.0154) 5支/卡	RM 2.60/Kad	75
9555 48350 0154		
3" (No.0161) 4支/卡	RM 3.40/Kad	76
9555 48350 0161		



S勾 (Qty: 12 Pek x 12 Ktk)

Penyangkut S SUPA	S. Price	
4" (No.0178) 3支/卡	RM 3.40/Kad	77
9555 48350 0178		



S勾 (Qty: 12 Pek x 12 Ktk)

Penyangkut S SUPA	S. Price	
5" (No.0185) 2支/卡	RM 3.40/Kad	78
9555 48350 0185		



50



蒼蠅紙 (Qty: 2000 Pcs x 1Ctn)

Pelekat Lalat Berbau SELL	S. Price
9555 48350 5609 (Ktk)	RM 45.00/Ktk
9555 48350 5500 (Pc)	

18



蒼蠅紙 (Qty: 2000 Pcs x 1 Ctn)

Pelekat Lalat Berbau KIBI	S. Price
9555 48350 0666 (Ktk)	RM 32.00/Ktk
9555 48350 0673 (Pc)	

79



50

封口机 (Qty: 10 Set x 1 Box)



Impulse Sealer	S. Price
20 cm 8"	60.00/Set
30 cm 12"	82.00/Set

14
16



封口机胶布 (Qty: 100 Pcs x 1 Ctn)

Sealer Tape	S. Price
20 cm (9555 48351 6377)	5.00/Pcs
30 cm (9555 48351 6384)	7.00/Pcs

109
110



50

竹簽

-35%



Lidi Satay	S. Price	
6" PROFESSOR (No.250)	RM 3.20/Pek	90
9555 48351 5578 (60 Pek)		
8" KIBI (No.500)	RM 5.90/Pek	95
9555 48351 5622 (60 Pek)		
8" PROFESSOR (No.700)	RM 8.20/Pek	91
9555 48351 5585 (50 Pek)		
10" PROFESSOR (No.1000)	RM 10.00/Pek	94
9555 48351 5015 (30 Pek)		
12" PROFESSOR (No.1000)	RM 10.00/Pek	96
9555 48351 5639 (30 Pek)		



SIN TAI SOON SDN. BHD. (116948-X)

新大順貿易有限公司

03

60



黑垃圾桶 (Qty: 1 Bks X 12 Pcs)

Baldi Hitam Poly	S. Price
70 Liter	RM 72.00/Pcs
90 Liter	RM 90.00/Pcs
120 Liter	RM 124.00/Pcs

22

46

47



SIN TAI SOON SDN. BHD. (116948-X)

新大順貿易有限公司

07

60



八安士纸杯 (Qty/Ctn: 20 Pcs x 120 Pek)

awan Kertas 8oz	S. Price
9555 48350 6637	RM3/PEK

1



SIN TAI SOON SDN. BHD. (116948-X)

新大順貿易有限公司

18

60



纸盘 (Qty: 100 Pek x 1 Ctn)

Pinggan Kertas	S. Price
7" - 9555 48350 6026	3.70/Pek
8" - 9555 48350 6149	4.20/Pek
9" - 9555 48350 6033	5.00/Pek

1

2

3



60



大噴水霧 (Qty: 10 Doz)

Pam Bunga Besar 1000 cc	S. Price
9555 48350 6187	RM 39.60/Doz

1



小噴水霧 (Qty: 10 Doz)

Pam Bunga Kecil 500cc	S. Price
9555 48350 6194	RM 36.00/Doz

2



小噴水霧 (Qty: 10 Doz)

Pam Bunga Kecil PET 500cc	S. Price
9555 48350 6866	RM 30.00/Doz

2-C



小噴水霧 (Qty: 10 Doz)

Botol Spray KIBI 500ml	S. Price
9555 48350 6958	RM 36.00/Doz

6



60

高压喷水罐



Pam Bunga High Pressure SELL	S. Price
1.0 Liter (Qty: 30 Pcs)	18.00/Pcs
9555 48350 6095	
1.5 Liter (Qty: 20 Pcs)	20.00/Pcs
9555 48350 6125	
2.0 Liter (Qty: 20 Pcs)	22.00/Pcs
9555 48350 6132	

3

4

5

高压喷水罐 (Qty: 30 Pcs X 5 Ctn)



Pam Bunga High Pressure OREN PET	S. Price
1.5 Liter	17.00/Pcs
9555 48350 6873	
2.0 Liter	18.00/Pcs
9555 48350 6880	

4-C

5-C



60



二十头衣夹 (Qty: 1 Doz x 12 Bks)

Sepit Baju Plastik 20 Pcs	S. Price
SD 203 - 9555 48350 6071	45.60/Doz

2



八头竹干衣夹 (Qty: 1 Doz x 12 Bks)

Sepit Baju Buluh 8 Pcs	S. Price
9555 48350 6446	36.00/Doz

3



60

二十公升白色水桶



Tong Cowboy	S. Price
25 Liter (Qty: 10 Pcs x 1 Ctn)	RM 43.00/Pcs
9555 48350 6507	
20 Liter (Qty: 12 Pcs x 1 Ctn)	RM 32.20/Pcs
9555 48350 6514	
15 Liter (Qty: 12 Pcs x 1 Ctn)	RM 29.00/Pcs
9555 48350 6897	
10 Liter (Qty: 21 Pcs x 1 Ctn)	RM 21.50/Pcs
9555 48350 6521	
30 Liter (Qty: 10 Pcs x 1 Ctn)	RM 48.00/Pcs
9555 48350 6989	

14

21

9

24

31



二十公升白色水桶 (Qty: 12 Pcs x 1 Ctn)

Tong Cowboy 20 Liter (KUNING)	S. Price
9555 48350 6941	RM 28.80/Pcs

21-K



60

五公升油桶 (Qty: 25 Pcs x 1 Ctn)



Bekas Air No.5	S. Price
9555 48350 6156	RM 7.90/Pcs

24



十公升油桶 (Qty: 15 Pcs x 2 Ctn)

Bekas Air No.10	S. Price
9555 48350 6934	RM 15.60/Pcs

27



60

200
201
202

蒼蠅拍 (Qty:12 Bks X 10 Pcs)

Pemukul Lalat	S. Price
	RM 1.50/Pcs

5



笨斗 (Qty: 1 Doz x 4 Bks)

Skop Sampah Kecil (EEP 8855)	S. Price
Batang Kayu Skru 螺丝木柄	RM 64.80/Doz
Tanpa Kayu	RM 45.60/Doz
9555 48350 6002	

300

600



笨斗 (Qty: 1 Doz x 4 Bks)

Skop Sampah 6200	S. Price
Batang Kayu Skru 螺丝木柄	RM 90.00/Doz
Tanpa Kayu	RM 70.80/Doz
9555 48350 6200	

300

600



60



锁匙牌 (Qty: 200 Pcs x 6 Bks)

Key Chain	S. Price
	RM 0.19/Pcs

9



锁匙牌 (Qty: 12 Kad x 12 Bks)

Key Chain	S. Price
10 Pcs - 9555 48350 8600	RM 3.80/Kad
40 Pcs - 9555 48350 8617	RM 11.20/Kad

20

21



锁匙圈 (Qty: 1000 Pcs x 5 Bks)

Key Ring 23mm	S. Price
	RM 90.00/Bks

19



70



羽毛球 (Qty: 50 Doz x 1 Ctn)

Bola Badminton AMUSI	S. Price
803 - 6932489 708037	RM 28.80/Doz

1



羽毛球 (Qty: 50 Doz x 1 Ctn)

Bola Badminton AMUSI	S. Price
406 - 6932489 700345	RM 48.00/Doz

2



羽毛球 (Qty: 50 Doz x 1 Ctn)

Bola Badminton AMUSI	S. Price
405 - 6932489 700338	RM 42.00/Doz

3



羽毛球 (Qty: 50 Doz x 1 Ctn)

Bola Badminton AMUSI	S. Price
404 - 6932489 700321	RM 39.00/Doz

5



70

19 cm



23 cm

棕油树皮革剪 (加大) (Qty: 80 Pcs x 1Ctn)

Gunting Steel Cap Kelapa Sawit 7054	S. Price
9555 48350 7054	RM 8.90/Pcs

5



308-8" 箭鱼牌仿韩剪刀 (Qty: 2 Doz x 15 ktk)



20 cm

Gunting Korea 308-8"	S. Price
Tanpa Papan	RM 36.00/Doz

16



70



剪刀 (QTY:6pcs x 8 Bks)

Gunting 7535	S. Price
9555 48350 7535	11.00/Pcs

25



剪刀 (QTY:6pcs x 8 Bks)

Gunting 7542	S. Price
9555 48350 7542	10.00/Pcs

26



70



海棉针 100gm (Qty: 1 Ctn x 24 Doz)

Jarum Peniti	S. Price
9555 48350 7986	RM 30.00/Doz

1



手针 (Qty: 1 Ctn x 120 Doz)

Jarum Tangan	S. Price
9555 48350 7702	RM 8.00/Doz

6



七彩珠针 (Qty: 12 Ktk x 3 Doz)

Jarum Tudung	S. Price
9555 48350 7993	RM 9.60/Doz

7



70

胶钉鞋 (Qty: 5 Psg x 6 Bks)



Kasut Kerja Getah Paku SIAP Tali 8836 (399)	S. Price
37/4	RM 9.60/Psg
38/5	RM 9.60/Psg
39/6	RM 9.60/Psg
40/7	RM 9.60/Psg
41/8	RM 9.60/Psg
42/9	RM 9.60/Psg
43/10	RM 9.60/Psg

14
15
16
17
18
19
20

无鞋带胶钉鞋 (Qty: 5 Psg x 6 Bks)



Kasut Kerja Getah Paku TANPA Tali 989	S. Price
38/5	RM 9.60/Psg
39/6	RM 9.60/Psg
40/7	RM 9.60/Psg
41/8	RM 9.60/Psg
42/9	RM 9.60/Psg
43/10	RM 9.60/Psg

27
28
29
30
31
32

无鞋带做工鞋 (Qty: 5 Psg x 6 Bks)



Kasut Kerja Getah Tanpa Tali 8835	S. Price
38	RM 8.90/Psg
39	RM 8.90/Psg
40	RM 8.90/Psg
41	RM 8.90/Psg
42	RM 8.90/Psg
43	RM 8.90/Psg

21
22
23
24
25
26



70

工鞋 (Qty: 5 Psg x 6 Bks)

Kasut Kerja Getah SIAP Tali (986)	S. Price
38/5	RM 8.90/Psg
39/6	RM 8.90/Psg
40/7	RM 8.90/Psg
41/8	RM 8.90/Psg
42/9	RM 8.90/Psg
43/10	RM 8.90/Psg

**3
4
5
6
7
8**



70



牛油 (Qty: 4 Ctn x 24 Pcs)

Grease 400gm SUPA	S. Price
9555 48350 7948	13.60/Pcs

15



(Qty: 12 Pcs x 10 Ktk)

TESON Silicone Sealant CLEAR 75gm	S. Price
9555 13450 2285	9.40/Pcs

18



(Qty: 12 Pcs x 10 Ktk)

TESON Silicone Sealant WHITE 75gm	S. Price
9555 13450 2285	9.40/Pcs

19



(Qty: 24 Pcs x 1 Ktk)

HARDEX Silicone Awning RS280-550	S. Price
500g (9555 48351 7466)	15.00/Pcs

20



70



针车油 (Qty: 2 Doz x 6 Ktk)

Minyak Mesin Asli Singer	S. Price
0037 43188 4619	RM 55.20/Doz

6



生锈油 (Qty: 24 Pcs x 5 Ktk)

Minyak 4D	S. Price
400ml - 9555 13450 2452	RM 13.80/Pcs
200ml - 9555 13450 2445	RM 9.80/Pcs

8
9



针车油 (Qty: 1 Doz x 12 Ktk)

Minyak Mesin Signal Reds	S. Price
~	RM 24.00/Doz

21



润滑脂(牛油)(Qty: 24 Pcs x 2 Ktk)

Spray Grease SW-99 400ml	S. Price
~	RM 21.00/Pcs

17



70



扑克牌 (Qty: 24 Doz x 3 Ctn)

Pakau JAWS 1001 Murah 4 Joker	S. Price
	16.40/Doz

1



扑克牌 (Qty: 24 Doz x 3 Ctn)

Pakau Kepala Jaws Asli 101 Plastic Coated	S. Price
9555 48350 7122 (Doz)	28.80/Doz
9555 48350 7009 (Ktk)	

2



扑克牌 (Qty: 1 Doz x 12 Box)

Pakau Plastik ROYAL 4 Joker	S. Price
9555 48351 7152	32.40/Doz

5



70



长图钉 (Qty/Ctn: 100 Ktk x 10 Pek)

Paku Tekan Panjang No. 206	S. Price
~	0.68/Ktk

1



短图钉 (Qty/Ctn: 50 Ktk x 20 Pek)

Paku Tekan Pendek No. 203	S. Price
~	0.60/Ktk

2



70



KENTO泰国日本鞋 (Qty: 12 Psg x 12 Bks)

Selipar Thailand KENTO Siap Barcode	S. Price
9555 48351 7381	RM 10.00/Psg

3

SIZE 9-10-11

4PSG/SIZE

博士牌鞋 (Qty: 10 Psg x 5 Bks)



Selipar Profesor	S. Price
9	RM 5.80/Psg
9 1/2	RM 5.80/Psg
10	RM 5.80/Psg
10 1/2	RM 5.80/Psg
11	RM 5.80/Psg
11 1/2	RM 6.10/Psg
12	RM 7.00/Psg

18

19

20

21

22

23

37



SIN TAI SOON SDN. BHD. (116948-X)

新大順貿易有限公司

25

70



厚庄学生袜 (Qty: 1 Doz x 20 Bks)

Stockin No.901	S. Price
9555 48351 7244	48.00/Doz

20



足球袜 (Qty: 1 Doz x 20 Bks)

Stockin Bola Sepak No.618	S. Price
9555 48351 7299	37.20/Doz

25



男庄运动袜 (Qty: 1 Doz x 20 Bks)

Stockin No.908	S. Price
9555 48351 7275	33.60/Doz

23



劳工袜 (Qty: 50 Doz x 1 Ctn)

Stocking Kerja 7429	S. Price
9555 48350 7429	21.60/Doz

4



SIN TAI SOON SDN. BHD. (116948-X)

20/10/22

新大順貿易有限公司

29

70



白臭丸 (Qty: 1 Peti x 150 Pek)

Ubat Gegat Putih 100g	S. Price
	RM 1.70/Pek

1



SIN TAI SOON SDN. BHD. (116948-X)

新大順貿易有限公司

32

70



梳子 (Qty: 30 Doz x 1 Ctn)

Sikat Kutu Plastik 302	S. Price
9555 48350 7955	9.60/Doz

7



梳子 (Qty: 24 Doz x 1 Ctn)

Sikat Kutu Plastik Bertangkai 402	S. Price
9555 48350 7962	12.00/Doz

8



70



800克合字早安巾 (Qty: 1 Doz x 50 Bks)

Good Morning Towel 800g Paling Tebal	S. Price
9555 48350 7979	55.00/Doz

11



360 克早安巾 (Qty: 1 Doz x 100 Bks)

Morning Towel 360g Biasa	S. Price
9555 48350 7283	18.60/Doz

12



480克早安巾 (Qty: 1 Doz x 100 Bks)

Morning Towel 480g Tebal	S. Price
9555 48350 8006	25.20/Doz

13



83新字毛巾 (Qty: 2 Doz x 50 Bks)

Good Morning Towel 83	S. Price
~	12.60/Doz

54



70



玻璃瓶金字墨汁 (Qty: 12 Doz x 3 Ctn)

Dakwat Cina Kin's	S. Price
~	RM 24.00/Doz 1



70



金鱼被 (Qty: 100 Pcs x 1 Ctn)

Selimum Cap Ikan Emas	S. Price
60 X 80	19.00/Pcs
9555 48350 7290	

33



金鱼被 (Qty: 80 Pcs x 1 Ctn)

Selimum Cap Ikan Emas	S. Price
70 X 90	33.00/Pcs
9555 48350 7320	

35

超纤面巾



Micro Fibre Tuala Muka	S. Price
13" x 30" (12 Pcs x 20 Bks)	7.60/Pcs
9555 48350 7313	
11" x 20" (12 Pcs x 30 Bks)	3.60/Pcs
9555 48350 7511	
12" x 12" (12 Pcs x 50 Bks)	2.70/Pcs
9555 48350 7528	
16" x 16" (12 Pcs x 30 Bks)	4.60/Pcs
9555 48350 7022	

34

40

41

47

SIN TAI SOON SDN. BHD. (116948-X)
新大順貿易有限公司
90
**03
14
05
15**

白抹 (Qty: 6 Doz X 1 Ctn)

Mop Putih No.300-240g	S. Price
Batang Kayu Putih 45" 光身螺牙柄带勾	RM 108.00/Doz
Batang Kayu Skru Color 48" 色螺丝柄	RM 108.00/Doz
Tanpa Kayu 无包柄	RM 84.00/Doz
9555 48350 9003	

400
500
600

白抹 (Qty: 6 Doz X 1 Ctn)

Mop Putih No.400-330g	S. Price
Batang Kayu Putih 45" 光身螺牙柄带勾	RM 126.00/Doz
Batang Kayu Skru Color 48" 色螺丝柄	RM 126.00/Doz
Tanpa Kayu 无包柄	RM 102.00/Doz
9555 48350 9034	

400
500
600

白抹 (Qty: 6 Doz X 1 Ctn)

Mop Putih No.500-400g	S. Price
Batang Kayu Putih 45" 光身螺牙柄带勾	RM 144.00/Doz
Batang Kayu Skru Color 48" 色螺丝柄	RM 144.00/Doz
Tanpa Kayu 无包柄	RM 120.00/Doz
9555 48350 9058	

400
500
600

白抹 (Qty: 6 Doz X 1 Ctn)

Mop Putih No.600-450g	S. Price
Batang Kayu Putih 45" 光身螺牙柄带勾	RM 160.00/Doz
Batang Kayu Skru Color 48" 色螺丝柄	RM 160.00/Doz
Tanpa Kayu 无包柄	RM 136.00/Doz
9555 48350 9065	

400
500
600

SIN TAI SOON SDN. BHD. (116948-X)
新大順貿易有限公司
**16
17**
90
纤维抹 (Qty: 12 Pcs x 5 Bks)

Mop Fibre (No.400) 350g	S. Price
Btg Kayu Skru Putih 48" 光身螺牙柄带勾	RM 15.80/Pcs
Batang Kayu Skru 木螺丝柄	RM 15.80/Pcs
Tanpa Kayu 无包柄	RM 13.60/Pcs
9555 48350 9072	

400
500
600

纤维抹 (Qty: 12 Pcs x 5 Bks)

Mop Fibre (No.350) 300g	S. Price
Btg Kayu Skru Putih 48" 光身螺牙柄带勾	RM 14.80/Pcs
Batang Kayu Skru 木螺丝柄	RM 14.80/Pcs
Tanpa Kayu 无包柄	RM 12.60/Pcs
9555 48350 9096	

400
500
600



80

椰骨扫 (Qty: 100 Pcs x 2 Beg x 1 Bdl)

Penyapu Lidi 400g ±	S. Price
~	RM 2.90/Pcs

1

塑胶头椰骨扫 (Qty: 72 Pcs x 1 Ctn)

Penyapu Lidi Kepala Plastik	S. Price
9555 48350 8204	RM 6.00/Pcs

4

塑胶头椰骨扫 (Qty: 25 Pcs x 2 Ctn)

Penyapu Lidi JW Kepala Plastik	S. Price
9555 48350 8341	RM 4.20/Pcs

4-JW

本地椰骨扫 (Qty: 50 Pcs x 1 Ctn)

Penyapu Lidi Rembia Local Panjang	S. Price
9555 48350 8105	RM 16.80/Pcs
Siap Pasang Kayu	

5300

本地椰骨扫 (Qty: 48 Pcs x 1 Ctn)

Penyapu Lidi Local Leper	S. Price
9555 48350 8112	RM 20.20/Pcs
Siap Pasang Kayu	

7300





SIN TAI SOON SDN. BHD. (116948-X)

新大順貿易有限公司

05

80

竹柄圆形椰骨扫 (Qty: 10 Pcs x 6 Ctn)

Penyapu Lidi Bulat 701	S. Price
9555 48350 8310	RM 11.50/Pcs

10-B

竹柄扁形椰骨扫 (Qty: 10 Pcs x 6 Ctn)

Penyapu Lidi Leper 701	S. Price
9555 48350 8303	RM 11.50/Pcs

10-L

竹柄葵骨扫 (Qty: 10 Pcs x 6 Ctn)

Penyapu Lidi Nipah Kasar 702	S. Price
9555 48350 8327	RM 12.80/Pcs

11



SIN TAI SOON SDN. BHD. (116948-X)

新大順貿易有限公司

071

80

木柄葵骨扫 (Qty: 12 Pcs x 6 Ikat x 1 Ctn)

Penyapu Lidi Nipah Kepala Plastik Siap Batang Kayu	S. Price
9555 48350 8334	RM 13.60/Pcs

400



80



花柄缅甸扫 (Qty: 10 Pcs x 40 Ikat)

Penyapu Jerami Bunga Burma	S. Price
~	RM 7.40/Pcs

11



缅甸扫 (Qty: 10 Pcs x 40 Ikat)

Penyapu Jerami Burma	S. Price
~	RM 6.90/Pcs

12-50



SIN TAI SOON SDN. BHD. (116948-X)

新大順貿易有限公司

80

333
988



胶头芒扫 (Qty: 60 Pcs x 1 Ctn)

Penyapu 333	S. Price
Batang Kayu Skru Panjang 47" 色螺丝柄	11.20/Pcs
Batang Kayu Skru Pendek 30" 色螺丝柄	10.50/Pcs
9555 48350 1236	

500

900



泰国芒扫 (Qty: 60 Pcs x 1 Ctn)

Penyapu Thailand 988	S. Price
Batang Kayu Skru Panjang 47"色螺丝柄	12.20/Pcs
Batang Kayu Skru Pendek 30" 色螺丝柄	11.50/Pcs
9555 47040 5769	

500

900

SIN TAI SOON SDN. BHD. (116948-X)

新大順貿易有限公司

80



天花板扫 (Qty: 12 Pcs x 5 Ikat)

Penyapu Sawang CB3	S. Price
Tanpa Kayu 无包柄	RM 5.70/Pcs
Batang Kayu 6Ft 6尺色木柄	RM 13.40/Pcs
9555 48350 8068	

081600

081700



天花板扫 (Qty: 12 Pcs x 5 Ikat)

Penyapu Sawang PCN 009	S. Price
Tanpa Kayu 无包柄	RM 7.40/Pcs
Batang Kayu Skru Berbalut 72"	RM 15.00/Pcs
9555 14800 7332	

084600

084800



打散丝天花板扫 (Qty: 12 Pcs x 5 Ikat)

Penyapu Sawang Berus Lebat PCN 008	S. Price
Tanpa Kayu 无包柄	RM 8.80/Pcs
Batang Kayu Skru Berbalut 72"	RM 16.40/Pcs
9555 14800 7516	

085600

085800



球型天花板扫 (Qty: 12 Pcs x 2 Ctn)

Penyapu Sawang	S. Price
Tanpa Kayu 无包柄	RM 15.60/Pcs
Batang Kayu 6Ft 6尺色木柄	RM 23.50/Pcs
Batang Kayu Skru Berbalut 72"	RM 23.50/Pcs
9555 66760 5187	

083600

083700

083800

SIN TAI SOON SDN. BHD. (116948-X)

新大順貿易有限公司
80
**2088
2022
1166**
黑金扫 (Qty: 12 Pcs x 4 Ktk)

Penyapu Hitam Mas 2088	S. Price
Batang Kayu Skru Putih 45" 光身螺牙柄带勾	RM 10.70/Pcs
Siap Batang Kayu Skru 45"	RM 10.70/Pcs
Tanpa Kayu	RM 8.20/Pcs
9555 48350 1090	

400
500
600
2022 金丝扫 (Qty: 12 Pcs x 4 Ctn)

Penyapu 2022	S. Price
Batang Kayu Skru Putih 45" 光身螺牙柄带勾	RM 10.70/Pcs
Siap Batang Kayu Skru 45"	RM 10.70/Pcs
Tanpa Kayu 无包柄	RM 8.20/Pcs
9555 48350 1083	

400
500
600
红蓝扫 (Qty: 15 Pcs x 4 Ctn)

Penyapu 1166	S. Price
Siap Batang Kayu Skru 45"	RM 12.20/Pcs
Tanpa Kayu	RM 9.70/Pcs
9555 48350 8280	

500
600



SIN TAI SOON SDN. BHD. (116948-X)

新大順貿易有限公司

80

5/1/22
929
929H
1388
2021

929 金丝扫 (Qty: 25 Pcs x 4 Ctn)



Penyapu Emas 929	S. Price
Batang Kayu Skru Putih 45" 光身螺牙柄带勾	11.30/Pcs
Batang Kayu Skru Color 48" 色螺丝柄	11.30/Pcs
Tanpa Kayu 无包柄	9.00/Pcs
9555 48350 1366	

400
500
600

929H 黑丝扫 (Qty: 25 Pcs x 4 Ctn)



Penyapu Emas 929H	S. Price
Batang Kayu Skru Putih 45" 光身螺牙柄带勾	11.30/Pcs
Batang Kayu Skru Color 48" 色螺丝柄	11.30/Pcs
Tanpa Kayu 无包柄	9.00/Pcs
9555 48350 1359	

400
500
600

1388 风水扫 (Qty: 24 Pcs x 1 Ctn)



Penyapu Feng Shui 1388	S. Price
Batang Besi 48" 铁柄	21.00/Pcs
Tanpa Batang Besi 无包柄	17.40/Pcs
9555 48350 8174	

100
600

2021 扫 (Qty: 24 Pcs x 3 Ctn)



Penyapu 2021	S. Price
Batang Kayu Skru Putih 45" 光身螺牙柄带勾	11.10/Pcs
Batang Kayu Skru Color 48" 色螺丝柄	11.10/Pcs
Tanpa Kayu 无包柄	8.60/Pcs
9555 48350 1007	

400
500
600



80

金头软丝扫 (Qty: 25 Pcs x 1 Ctn)



Penyapu 2017	S. Price
Batang Kayu Skru Putih 45" 光身螺牙柄带勾	9.30/Pcs
Batang Kayu Skru Color 48" 色螺丝柄	9.30/Pcs
Tanpa Kayu 无包柄	6.80/Pcs
9555 48350 8129	

400
500
600

金头软丝扫 (Qty: 25 Pcs x 1 Ctn)



Penyapu A14	S. Price
Batang Kayu Skru Putih 45" 光身螺牙柄带勾	9.30/Pcs
Batang Kayu Skru Color 48" 色螺丝柄	9.30/Pcs
Tanpa Kayu 无包柄	6.80/Pcs
9555 48350 8099	

400
500
600

SIN TAI SOON SDN. BHD. (116948-X)

新大順貿易有限公司

80

018 212 8242

硬丝扫 (Qty: 50 Pcs x 1 Ctn)

Penyapu Plastik 018	S. Price
Batang Kayu Skru Putih 45" 光身螺牙柄带勾	7.90/Pcs
Batang Kayu Skru Color 48" 色螺丝柄	7.90/Pcs
Tanpa Kayu 无包柄	5.40/Pcs
9555 48350 1342	

400 500 600

硬丝扫 (Qty: 50 Pcs x 1 Ctn)

Penyapu Plastik 212	S. Price
Batang Kayu Skru Putih 45" 光身螺牙柄带勾	7.90/Pcs
Batang Kayu Skru Color 48" 色螺丝柄	7.90/Pcs
Tanpa Kayu 无包柄	5.40/Pcs
9555 48350 1298	

V\$S 400 500 600

8242 硬丝扫 (Qty: 50 Pcs x 1 Ctn)

Penyapu 8242	S. Price
Batang Kayu Skru Putih 45" 光身螺牙柄带勾	7.50/Pcs
Batang Kayu Skru Color 48" 色螺丝柄	7.50/Pcs
Tanpa Kayu 无包柄	5.80/Pcs
9555 48350 8242	

400 500 600

SIN TAI SOON SDN. BHD. (116948-X)

新大順貿易有限公司
2880
8801

80

洗地刷 (Qty: 50 Pcs x 1 Ctn)

Penyapu Longkang 2880	S. Price
Batang Kayu Skru Putih 45"	9.70/Pcs
Btg Kayu Skru Color 48" 色螺丝柄	9.70/Pcs
Tanpa Kayu 无包柄	7.20/Pcs
9555 48350 8136	

400
500
600
打散丝扫 (Qty: 25 Pcs x 1 Ctn)

Penyapu 8801	S. Price
Batang Kayu Skru Putih 45"	7.40/Pcs
Btg Kayu Skru Color 48" 色螺丝柄	7.40/Pcs
Tanpa Kayu 无包柄	5.00/Pcs
9555 48350 1199	

400
500
600



80

14/11/22
707
808
605
318

小湾地刷 (Qty: 72 Pcs x 1 Ctn)



Penyapu Longkang Bangkok Kecil 707	S. Price	V\$N
Batang Kayu Putih 45" 光身螺牙柄带勾	RM 7.60/Pcs	400
Batang Kayu Skru Color 48" 色螺丝柄	RM 7.60/Pcs	500
Tanpa Kayu 无包柄	RM 5.40/Pcs	600
9555 48350 1175		

腰形洗地刷 (Qty: 72 Pcs x 1 Ctn)



Penyapu Longkang 808	S. Price	V\$N
Batang Kayu Putih 45" 光身螺牙柄带勾	RM 8.70/Pcs	400
Batang Kayu Skru Color 48" 色螺丝柄	RM 8.70/Pcs	500
Tanpa Kayu 无包柄	RM 6.60/Pcs	600
9555 48350 1120		

塑料头小沟刷 (Qty: 72 Pcs x 1 Ctn)



Penyapu Longkang Kecil 605	S. Price	V\$N
Batang Kayu Putih 45" 光身螺牙柄带勾	RM 7.20/Pcs	400
Batang Kayu Skru Color 48" 色螺丝柄	RM 7.20/Pcs	500
Tanpa Kayu 无包柄	RM 5.00/Pcs	600
9555 48350 1144		

塑料头大沟刷 (Qty: 50 Pcs x 1 Ctn)



Penyapu Longkang Besar 318	S. Price	V\$N
Batang Kayu Putih 45" 光身螺牙柄带勾	RM 9.00/Pcs	400
Batang Kayu Skru Color 48" 色螺丝柄	RM 9.00/Pcs	500
Tanpa Kayu 无包柄	RM 6.80/Pcs	600
9555 48350 1137		

SIN TAI SOON SDN. BHD. (116948-X)
新大順貿易有限公司

80

917
918
3928
09

917 波纹扫 (Qty: 50 Pcs x 1 Ctn)

Penyapu 917	S. Price	
Batang Kayu Skru Color 48" 色螺丝柄	RM 9.50/Pcs	500
Tanpa Kayu 无包柄	RM 7.00/Pcs	600
Batang Kayu Skru Color 31" 色螺丝柄	RM 8.80/Pcs	900
9555 48350 1243		

918 波纹扫 (Qty: 50 Pcs x 1 Ctn)

Penyapu 918	S. Price	
Batang Kayu Skru Color 48" 色螺丝柄	RM 7.90/Pcs	500
Tanpa Kayu 无包柄	RM 5.40/Pcs	600
Batang Kayu Skru Color 31" 色螺丝柄	RM 7.20/Pcs	900
9555 48350 1250		

3928 扫 (Qty: 50 Pcs x 1 Ctn)

Penyapu Jumbo 3928	S. Price	
Batang Kayu Skru Color 48" 色螺丝柄	RM 9.50/Pcs	500
Tanpa Kayu 无包柄	RM 7.00/Pcs	600
Batang Kayu Skru Color 31" 色螺丝柄	RM 8.80/Pcs	900
9555 48350 1076		

胶头黑棕扫 (Qty: 100 Pcs x 1 Ctn)

Penyapu Sabut Hitam	S. Price	
Batang Kayu Putih 45" 光身螺牙柄带勾	RM 12.00/Pcs	400
Batang Kayu Skru Color 48" 色螺丝柄	RM 12.00/Pcs	500
Tanpa Kayu 无包柄	RM 9.20/Pcs	600
9555 48350 8297		



80

888
999
902

888 扇子扫 (Qty: 50 Pcs x 1 Ctn)



Penyapu Kipas Color 888	S. Price
Batang Kayu Skru Color 48" 色螺丝柄	7.50/Pcs
Tanpa Kayu 无包柄	5.00/Pcs
Batang Kayu Skru Color 31" 色螺丝柄	6.80/Pcs
9555 48350 1045	

500

600

900

999 黑色扇子扫 (Qty: 50 Pcs x 1 Ctn)



Penyapu Kipas Hitam 999	S. Price
Batang Kayu Skru Color 48" 色螺丝柄	7.50/Pcs
Tanpa Kayu 无包柄	5.00/Pcs
Batang Kayu Skru Color 31" 色螺丝柄	6.80/Pcs
9555 48350 1052	

500

600

900

902 波纹扫 (Qty: 50 Pcs x 1 Ctn)



Penyapu Kipas Color 902	S. Price
Batang Kayu Skru Color 48" 色螺丝柄	8.30/Pcs
Tanpa Kayu 无包柄	5.80/Pcs
Batang Kayu Skru Color 31" 色螺丝柄	7.60/Pcs
9555 48350 8211	

500

600

900

SIN TAI SOON SDN. BHD. (116948-X)
新大順貿易有限公司

80

木头硬丝扫 (Qty: 12 Pcs x 12 Ikat)

Penyapu No. 51	S. Price
Batang Kayu Skru Putih 45" 光身螺牙柄带勾	8.70/Pcs
Batang Kayu Skru Color 48"	8.70/Pcs
Tanpa Kayu 无包柄	6.20/Pcs
9555 48350 4183	

41400
41500
41600
木头打散丝扫 (Qty: 10 Pcs x 6 Ikat)

Penyapu PCN 88	S. Price
Batang Kayu Skru Putih 45" 光身螺牙柄带勾	10.70/Pcs
Batang Kayu Skru Color 48"	10.70/Pcs
Tanpa Kayu 无包柄	8.20/Pcs
9555 14800 1194	

78400
78500
78600

SIN TAI SOON SDN. BHD. (116948-X)
新大順貿易有限公司

09

80

马标胶头黑棕扫 (Qty: 100 Pcs x 1 Ctn)

Penyapu Hitam Cap Kuda	S. Price
Siap Batang Kayu Skru 45"	9.40/Pcs
Tanpa Kayu	7.00/Pcs

500
600



90



塑膠推水扫 (Qty: 72 Pcs x 1 Ctn)

6128 Tolak Air Professor	S. Price
Tanpa Kayu 无包柄	9.80/Pcs
Kayu Skru Color 48" 色螺丝柄	12.00/Pcs
Kayu Skru Putih 45" 光身螺牙柄带勾	12.00/Pcs

600
500
400

塑膠推水扫 (Qty: 72 Pcs x 1 Ctn)



9898 Tolak Air Professor	S. Price
Tanpa Kayu 无包柄	7.00/Pcs
Kayu Skru Color 48" 色螺丝柄	9.20/Pcs
Kayu Skru Putih 45" 光身螺牙柄带勾	9.20/Pcs

600
500
400



100

02
11
012
065

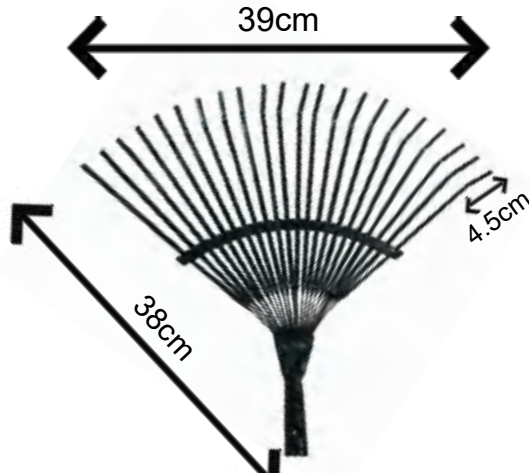

铁草耙 (Qty: 60 Pcs X 1 Ctn)

Cakar Besi 1908	S. Price
Tanpa Kayu 无包柄	RM 8.00/Pcs
Siap Kayu	RM 10.80/Pcs
9555 48350 7139	

600
300

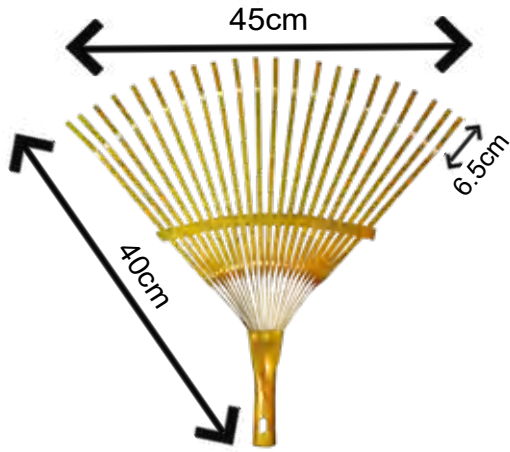

钢铁草耙 (Qty: 36 Pcs X 1 Ctn)

Cakar Besi Tebal 1358 S/Steel	S. Price
Tanpa Kayu 无包柄	RM 12.00/Pcs
Siap Kayu	RM 14.80/Pcs
9555 48351 1358	

600
300

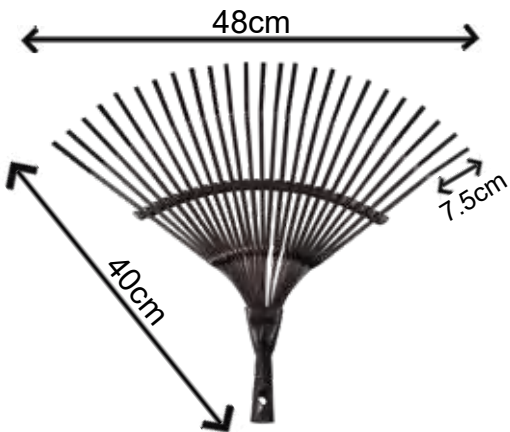

钢铁草耙 (Qty: 30 Pcs X 1 Ctn)

Cakar Besi Tebal Besar 0313	S. Price
Tanpa Kayu 无包柄	RM 13.80/Pcs
Siap Kayu	RM 16.60/Pcs
9555 48351 0313	

600
300

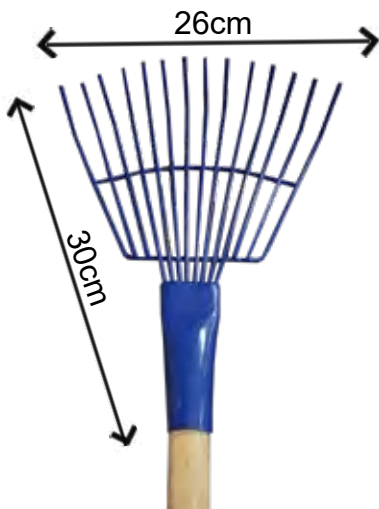

14牙本地铁钉耙 (Qty: 5 Pcs X 12 Ikat)

Cakar Besi Tajam 14 Mata	S. Price
Tanpa Kayu 无包柄	RM 21.80/Pcs
Siap Kayu	RM 30.00/Pcs
9555 48351 0344	

600
300



01
04
09
10

100

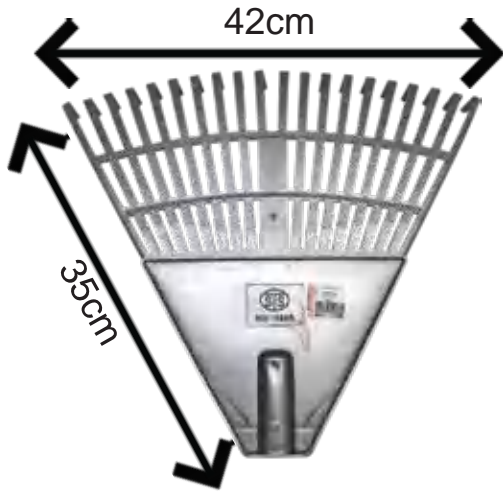

塑膠草耙 (Qty: 120 Pcs x 1 Ctn)

Cakar PVC 0680	S. Price
Tanpa Kayu 无包柄	RM 2.60/Pcs
SIAP Kayu Skru Putih 48"	RM 4.80/Pcs
9555 48350 0680	

600
400

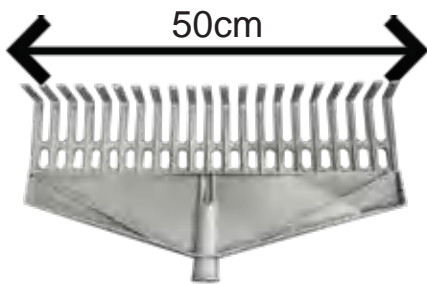

塑膠草耙 (Qty: 40 Pcs x 1 Ctn)

Cakar PVC 1338	S. Price
Tanpa Kayu 无包柄	RM 5.80/Pcs
SIAP Kayu Skru Putih 48"	RM 8.00/Pcs
9555 48350 1748	

600
400

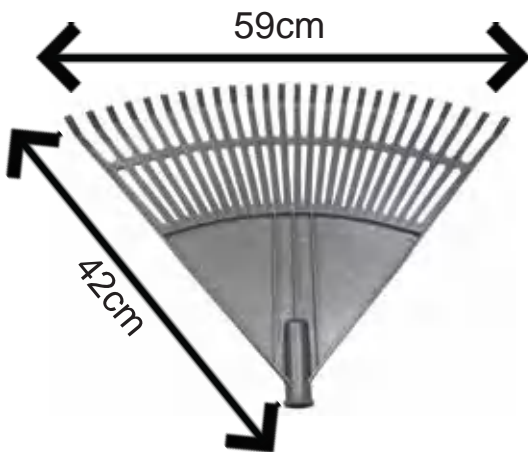

塑膠草耙 (Qty: 50 Pcs x 1 Ctn)

Cakar PVC 260	S. Price
Tanpa Kayu 无包柄	RM 9.20/Pcs
SIAP Kayu 4Ft"	RM 11.40/Pcs
9555 48350 1892	

600
00

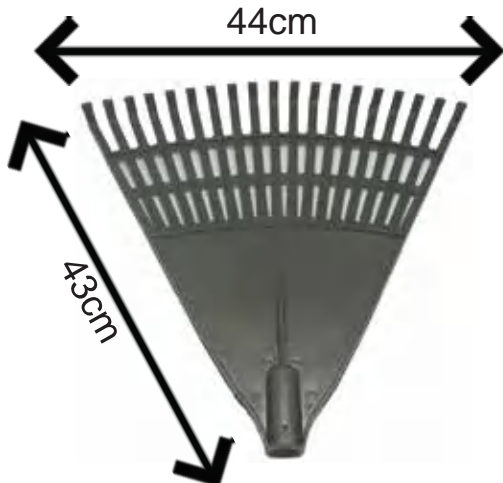

塑膠草耙 (Qty: 60 Pcs x 1 Ctn)

Cakar PVC 0697	S. Price
Tanpa Kayu 无包柄	RM 4.75/Pcs
SIAP Kayu Skru Putih 48"	RM 6.95/Pcs
9555 48350 0697	

600
400



100

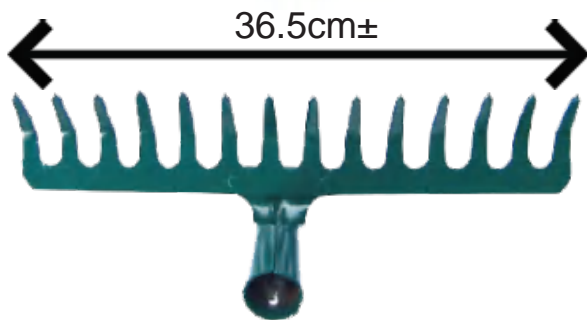
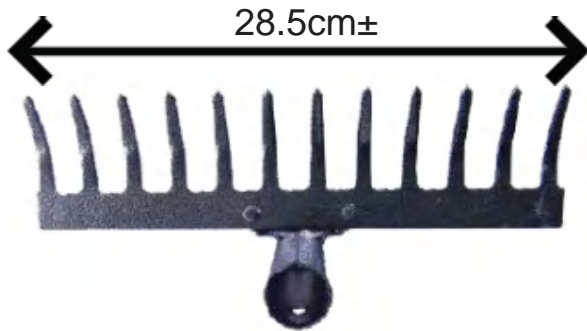

草耙 (24 Pcs x 3 Ctn)

Cakar Leper Nipis	S. Price
12 Mata	8.00/Pcs
9555 48351 4052	
14 Mata	10.00/Pcs

4

5